

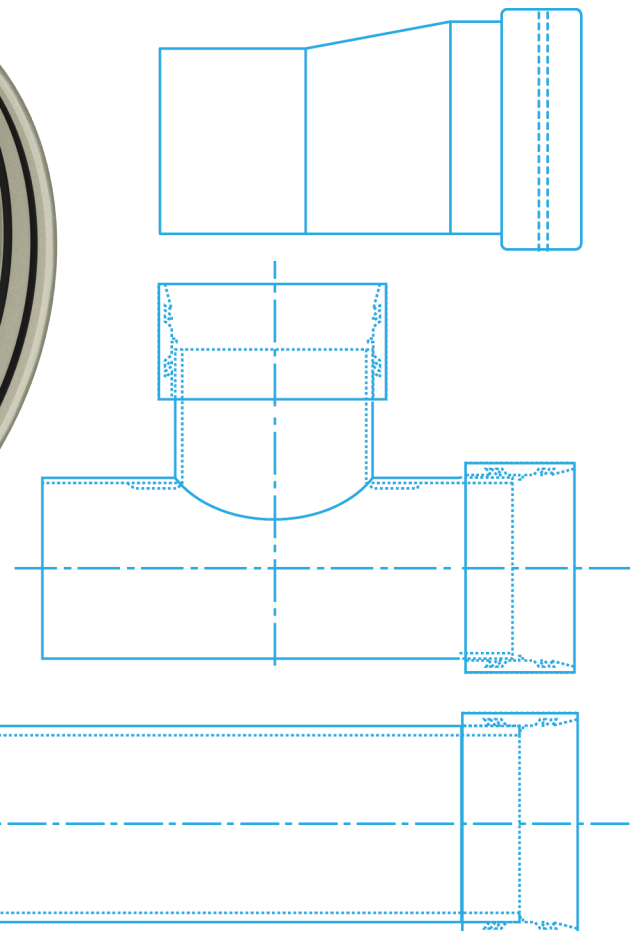

# Flowtite GRP non-pressure pipe systems

Technical product data

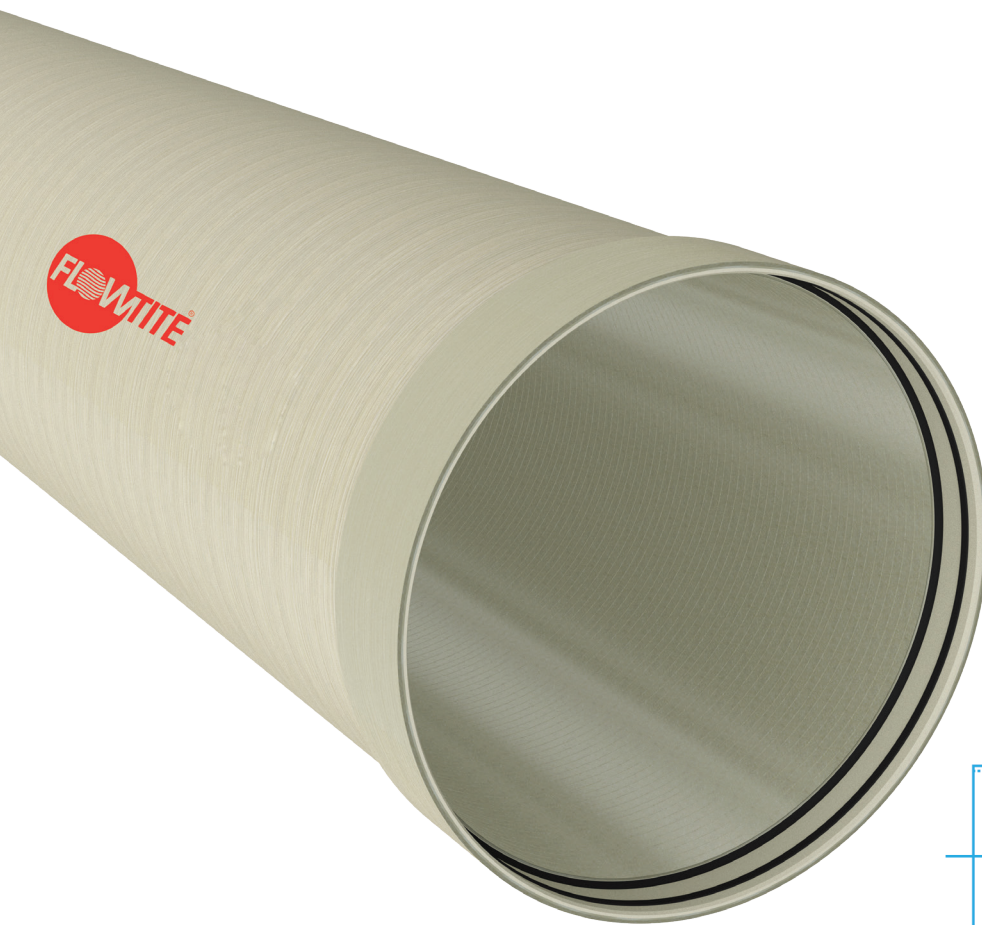



# Contents

|                    | Page                                   |
|--------------------|----------------------------------------|
|                    | 4 Abbreviations                        |
| <b>PIPES</b>       | 5 Non-pressure pipe                    |
| <b>PIPE JOINTS</b> | 7 Joints and Couplings                 |
|                    | 9 Flowtite Non-pressure Coupling (FSC) |
| <b>FITTINGS</b>    | 10 Segmented Elbow                     |
|                    | 12 T-Piece Concentric                  |
|                    | 21 T-Piece Eccentric                   |
|                    | 29 Reducer                             |
|                    | 31 y-Piece 45°                         |
|                    | 40 y-Piece 60°                         |
|                    | 49 Notes                               |



This version replaces all previous versions. For all current data and values please visit [www.amiblu.com](http://www.amiblu.com).

# Abbreviations

|          |                                              |
|----------|----------------------------------------------|
| $\alpha$ | Angle                                        |
| B1       | $d_e$ to product standard (EN 1796/EN 14364) |
| B2       | $d_e$ to GRP and casting standards           |
| B3       | $d_e$ to GRP and PVC standards               |
| B4       | $d_e$ to GRP and steel standards             |
| BE       | Branch eccentricity                          |
| BL       | Branch length / Bend length                  |
| BLL      | Branch laying length                         |
| BP       | Branch position                              |
| $d_e$    | External diameter                            |
| $d_{eB}$ | External diameter branch                     |
| $d_{eH}$ | External diameter header                     |
| $d_{eL}$ | External diameter large                      |
| $d_{eS}$ | External diameter small                      |

|        |                         |
|--------|-------------------------|
| DN     | Nominal diameter        |
| $DN_B$ | Nominal diameter branch |
| $DN_H$ | Nominal diameter header |
| $DN_L$ | Nominal diameter large  |
| $DN_S$ | Nominal diameter small  |
| DS     | Diameter series         |
| e      | Wall thickness          |
| HLL    | Header laying length    |
| LL     | Laying length           |
| LN     | Nominal length          |
| m      | Weight                  |
| PN     | Nominal pressure        |
| R      | Radius                  |
| SN     | Nominal stiffness       |

# Non-pressure Pipe

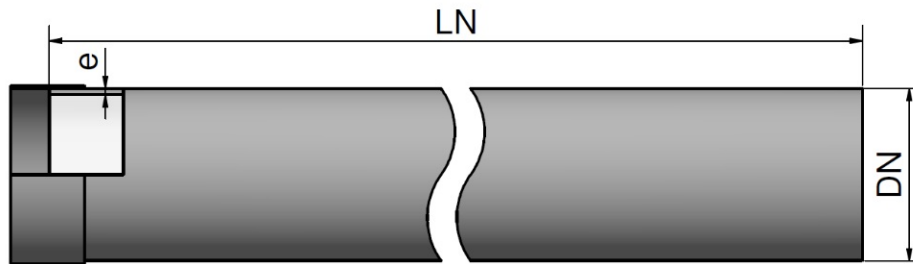

Portfolio as sold by Amiblu. For the full range of the Flowtite technology, visit [www.flowtite.com](http://www.flowtite.com).

| DN   | DS | d <sub>e</sub><br>[mm] | SN 2500     |           | SN 5000     |           | SN 10000    |           |
|------|----|------------------------|-------------|-----------|-------------|-----------|-------------|-----------|
|      |    |                        | m<br>[kg/m] | e<br>[mm] | m<br>[kg/m] | e<br>[mm] | m<br>[kg/m] | e<br>[mm] |
| 200  | B2 | 220                    |             |           |             |           | 7           | 6         |
| 250  | B2 | 272                    |             |           |             |           | 10          | 6         |
| 300  | B2 | 324                    | 9           | 4         | 12          | 5         | 15          | 7         |
| 350  | B2 | 376                    | 13          | 5         | 16          | 6         | 20          | 8         |
| 400  | B2 | 427                    | 16          | 6         | 21          | 7         | 27          | 9         |
| 450  | B2 | 478                    | 21          | 6         | 26          | 8         | 33          | 10        |
| 500  | B2 | 530                    | 26          | 7         | 33          | 9         | 41          | 11        |
| 600  | B1 | 617                    | 35          | 8         | 44          | 10        | 53          | 12        |
| 700  | B1 | 719                    | 48          | 10        | 58          | 12        | 72          | 14        |
| 800  | B1 | 821                    | 61          | 11        | 74          | 13        | 94          | 16        |
| 900  | B1 | 923                    | 77          | 12        | 94          | 14        | 118         | 18        |
| 1000 | B1 | 1025                   | 92          | 13        | 118         | 16        | 145         | 20        |
| 1100 | B1 | 1127                   | 111         | 14        | 140         | 18        | 174         | 22        |
| 1200 | B1 | 1229                   | 135         | 16        | 168         | 19        | 206         | 24        |
| 1300 | B1 | 1331                   | 156         | 17        | 195         | 21        | 240         | 25        |
| 1400 | B1 | 1433                   | 181         | 18        | 226         | 22        | 279         | 27        |
| 1500 | B1 | 1535                   | 209         | 19        | 257         | 24        | 318         | 29        |
| 1600 | B1 | 1637                   | 235         | 20        | 290         | 25        | 360         | 31        |

The standard pipe lengths are 3, 6, and 12 m (3 and 6 m for DN 200). Other lengths are available on request.

Other stiffness classes are available on request.

The table data above refers to the Flowtite Standard Sewer Pipe design.

The pipe design is tested for water jetting resistance according to DIN 19523. Please contact your representative for detailed information regarding requirements for water jetting.

# Non-pressure Pipe

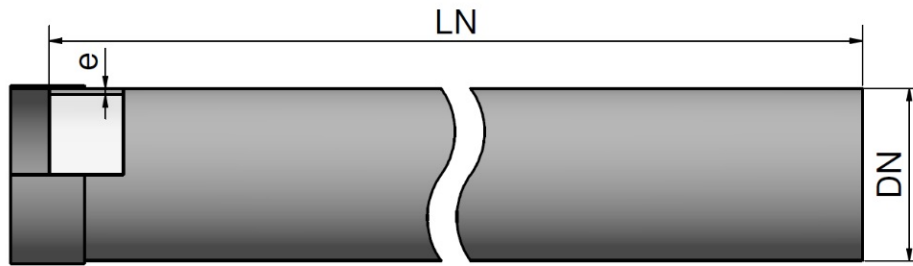

Portfolio as sold by Amiblu. For the full range of the Flowtite technology, visit [www.flowtite.com](http://www.flowtite.com).

| DN   | DS | d <sub>e</sub><br>[mm] | SN 2500     |           | SN 5000     |           | SN 10000    |           |
|------|----|------------------------|-------------|-----------|-------------|-----------|-------------|-----------|
|      |    |                        | m<br>[kg/m] | e<br>[mm] | m<br>[kg/m] | e<br>[mm] | m<br>[kg/m] | e<br>[mm] |
| 1700 | B1 | 1739                   | 266         | 21        | 329         | 27        | 408         | 33        |
| 1800 | B1 | 1841                   | 295         | 22        | 366         | 28        | 453         | 35        |
| 1900 | B1 | 1943                   | 328         | 24        | 408         | 30        | 503         | 37        |
| 2000 | B1 | 2045                   | 360         | 25        | 449         | 31        | 555         | 38        |
| 2100 | B1 | 2147                   | 399         | 26        | 496         | 33        | 610         | 40        |
| 2200 | B1 | 2249                   | 434         | 27        | 541         | 34        | 671         | 42        |
| 2300 | B1 | 2351                   | 473         | 28        | 592         | 35        | 732         | 44        |
| 2400 | B1 | 2453                   | 514         | 29        | 641         | 37        | 798         | 46        |

Flowtite pipes are available up to DN 4000. Please turn to your local sales representative for more information.

The standard pipe lengths are 3, 6, and 12 m (3 and 6 m for DN 200). Other lengths are available on request.

Other stiffness classes are available on request.

The table data above refers to the Flowtite Standard Sewer Pipe design.

The pipe design is tested for water jetting resistance according to DIN 19523. Please contact your representative for detailed information regarding requirements for water jetting.

## Joins and Couplings

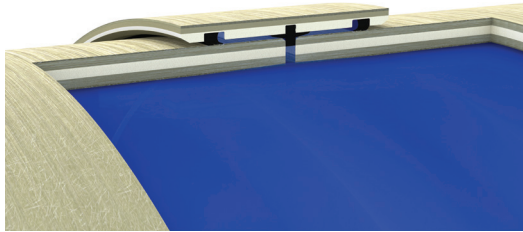

### Flowtite Non-pressure Coupling (FSC)

Diameter range (DN): 200 - 3000 mm  
Angular deflection\*: up to 3°

\* The degree of angular deflection depends on the pipe diameter. Please contact Amiblu for further information.

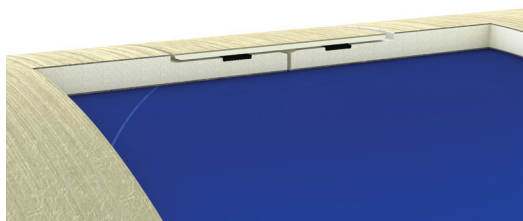

### GRP Sleeve

Diameter range (de): 272 - 3600 mm

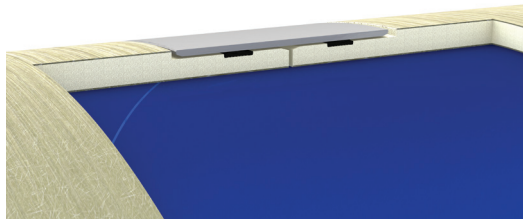

### Stainless Steel Sleeve

Diameter range (de): 272 - 3600 mm

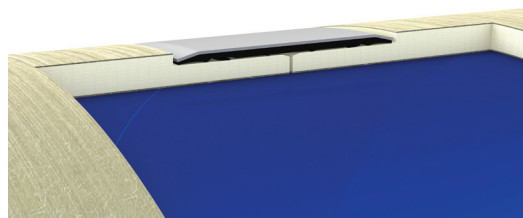

### Stainless Steel Sleeve With Integrated Rubber Seal

Diameter range (de): 272 - 2500 mm

## Field Joints for Pressure & Gravity Applications

Laminated field joints are available in uniaxial and biaxial designs. Amiblu provides the necessary instructions or skilled personnel for butt-wrap joining in pressure and non-pressure applications. Technologies developed by Amiblu provide faster and more cost-efficient installations.

## Masonry Couplings

The masonry coupling is used for connecting pipes to concrete shafts and walls. Masonry couplings are sanded for improved stability in concrete shafts. Masonry couplings can be delivered with pipe ring, and optionally with sealing tape. Lengths can be selected as required in consideration of the pipe joint data.

## Mechanical Couplings

Amiblu pipes can be joined using mechanical steel couplings such as tangential bolt couplings or axial bolt couplings.

## Amiblu Flanges

Amiblu manufactures and sells flanges in various designs and according to different standards and requirements. When connecting two GRP flanges, the standard bolt pattern to which flanges are manufactured is EN 1092. Other bolting dimension systems such as according to AWWA, ANSI, DIN, and JIS can be supplied.

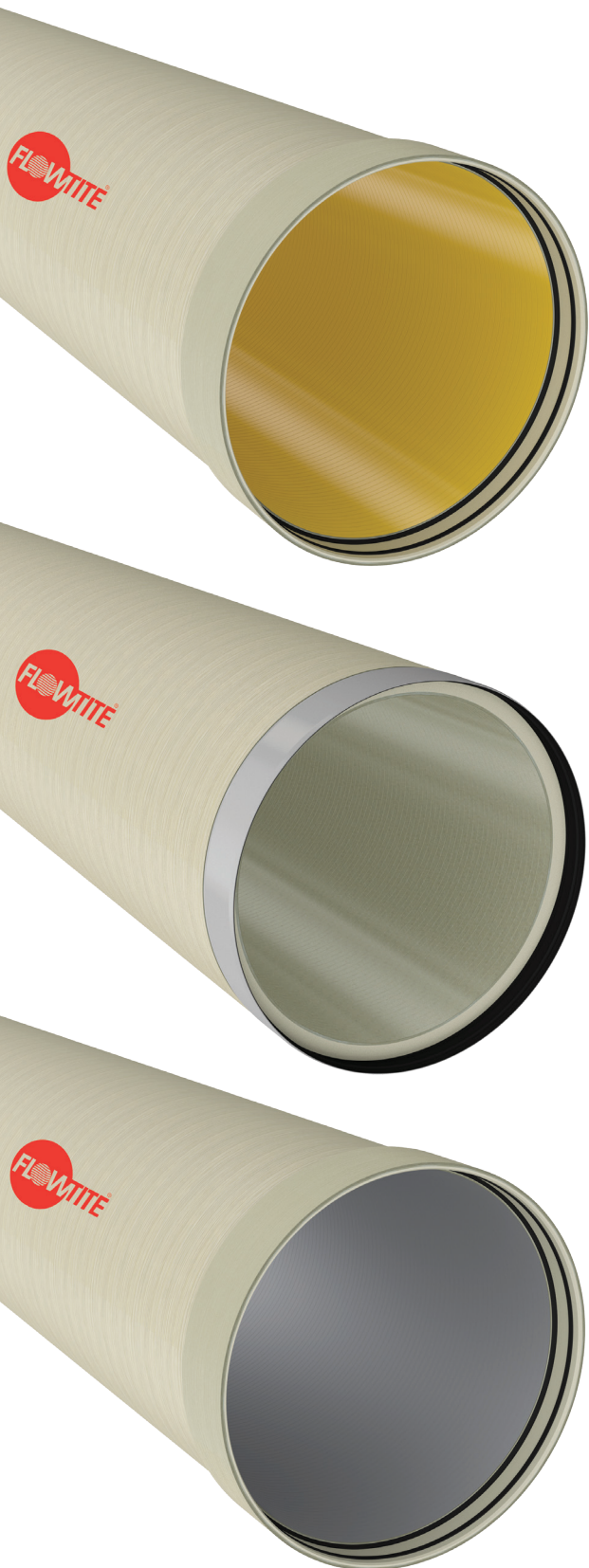

Amiblu offers a broad portfolio of filament wound Flowtite GRP pipe systems for various applications and installation methods, e.g. jacking pipes, relining pipes, special pipes with highly durable inner liner, and many more. For the complete range of offered products, please visit [www.amiblu.com](http://www.amiblu.com).



# Flowtite Non-pressure Coupling (FSC)

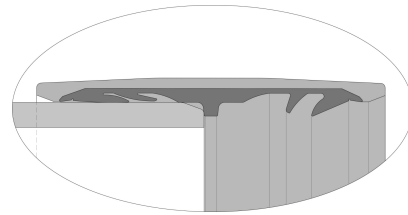

| DN   | De [mm] | LC [mm] | DEC min [mm] |
|------|---------|---------|--------------|
| 300  | 324     | 240     | 356          |
| 350  | 376     | 240     | 408          |
| 400  | 427     | 240     | 459          |
| 450  | 478     | 240     | 510          |
| 500  | 530     | 240     | 562          |
| 600  | 617     | 240     | 649          |
| 700  | 719     | 240     | 752          |
| 800  | 821     | 240     | 855          |
| 900  | 923     | 240     | 958          |
| 1000 | 1025    | 240     | 1061         |
| 1100 | 1127    | 240     | 1163         |
| 1200 | 1229    | 240     | 1266         |

| DN   | De [mm] | LC [mm] | DEC min [mm] |
|------|---------|---------|--------------|
| 1300 | 1331    | 270     | 1381         |
| 1400 | 1433    | 270     | 1484         |
| 1500 | 1535    | 270     | 1586         |
| 1600 | 1637    | 270     | 1689         |
| 1700 | 1739    | 270     | 1791         |
| 1800 | 1841    | 270     | 1893         |
| 1900 | 1943    | 270     | 1996         |
| 2000 | 2045    | 270     | 2098         |
| 2100 | 2147    | 270     | 2201         |
| 2200 | 2249    | 270     | 2303         |
| 2300 | 2351    | 270     | 2405         |
| 2400 | 2453    | 270     | 2508         |

# Segmented Elbow PN 1

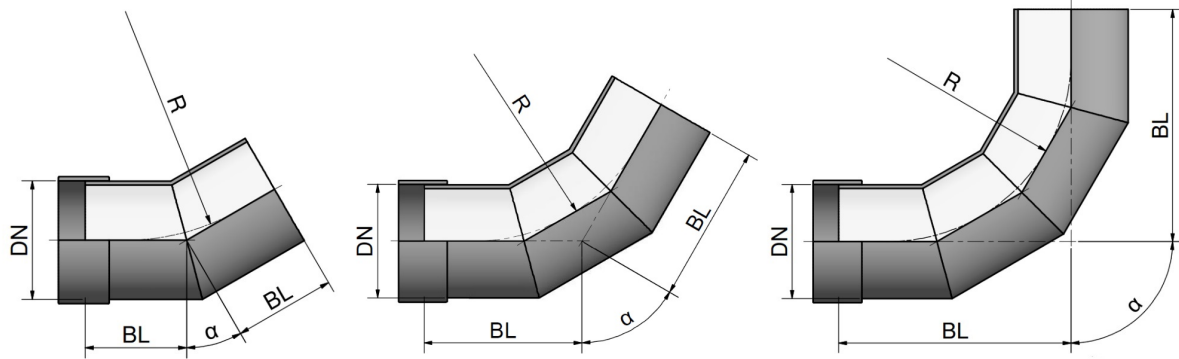

| Angle $\alpha^*$ : |               | 11.25°    |            | 15°       |            | 22.5°     |            | 30°       |            | 45°       |            | 60°       |            | 90°       |            |
|--------------------|---------------|-----------|------------|-----------|------------|-----------|------------|-----------|------------|-----------|------------|-----------|------------|-----------|------------|
| Segments:          |               | 2         |            | 2         |            | 2         |            | 2         |            | 3         |            | 3         |            | 4         |            |
| DN                 | $d_e$<br>[mm] | R<br>[mm] | BL<br>[mm] | R<br>[mm] | BL<br>[mm] | R<br>[mm] | BL<br>[mm] | R<br>[mm] | BL<br>[mm] | R<br>[mm] | BL<br>[mm] | R<br>[mm] | BL<br>[mm] | R<br>[mm] | BL<br>[mm] |
| 200                | 220           | 300       | 250        | 300       | 250        | 300       | 250        | 300       | 250        | 300       | 300        | 300       | 350        | 300       | 500        |
| 250                | 272           | 375       | 250        | 375       | 250        | 375       | 250        | 375       | 250        | 375       | 350        | 375       | 400        | 375       | 550        |
| 300                | 324           | 450       | 300        | 450       | 300        | 450       | 300        | 450       | 300        | 450       | 400        | 450       | 450        | 450       | 650        |
| 350                | 376           | 525       | 300        | 525       | 300        | 525       | 300        | 525       | 300        | 525       | 400        | 525       | 500        | 525       | 700        |
| 400                | 427           | 600       | 350        | 600       | 350        | 600       | 350        | 600       | 350        | 600       | 450        | 600       | 500        | 600       | 750        |
| 450                | 478           | 675       | 350        | 675       | 350        | 675       | 350        | 675       | 350        | 675       | 450        | 675       | 550        | 675       | 850        |
| 500                | 530           | 750       | 350        | 750       | 350        | 750       | 350        | 750       | 350        | 750       | 500        | 750       | 600        | 750       | 900        |
| 600                | 617           | 900       | 350        | 900       | 350        | 900       | 350        | 900       | 350        | 900       | 550        | 900       | 650        | 900       | 1000       |
| 700                | 719           | 1050      | 400        | 1050      | 400        | 1050      | 400        | 1050      | 400        | 1050      | 600        | 1050      | 700        | 1050      | 1150       |
| 800                | 821           | 1200      | 400        | 1200      | 400        | 1200      | 400        | 1200      | 400        | 1200      | 650        | 1200      | 800        | 1200      | 1300       |
| 900                | 923           | 1350      | 450        | 1350      | 450        | 1350      | 450        | 1350      | 450        | 1350      | 700        | 1350      | 850        | 1350      | 1400       |
| 1000               | 1025          | 1500      | 450        | 1500      | 450        | 1500      | 450        | 1500      | 450        | 1500      | 750        | 1500      | 900        | 1500      | 1550       |
| 1100               | 1127          | 1650      | 450        | 1650      | 450        | 1650      | 450        | 1650      | 450        | 1650      | 750        | 1650      | 950        | 1650      | 1650       |
| 1200               | 1229          | 1800      | 450        | 1800      | 450        | 1800      | 450        | 1800      | 450        | 1800      | 800        | 1800      | 1050       | 1800      | 1800       |
| 1300               | 1331          | 1950      | 500        | 1950      | 500        | 1950      | 500        | 1950      | 500        | 1950      | 900        | 1950      | 1100       | 1950      | 1950       |
| 1400               | 1433          | 2100      | 500        | 2100      | 500        | 2100      | 500        | 2100      | 500        | 2100      | 950        | 2100      | 1150       | 2100      | 2050       |
| 1500               | 1535          | 2250      | 550        | 2250      | 550        | 2250      | 550        | 2250      | 550        | 2250      | 1000       | 2250      | 1250       | 2250      | 2200       |
| 1600               | 1637          | 2400      | 550        | 2400      | 550        | 2400      | 550        | 2400      | 550        | 2400      | 1050       | 2400      | 1300       | 2400      | 2350       |
| 1700               | 1739          | 2550      | 600        | 2550      | 600        | 2550      | 600        | 2550      | 600        | 2550      | 1100       | 2550      | 1400       | 2550      | 2500       |
| 1800               | 1841          | 2700      | 600        | 2700      | 600        | 2700      | 600        | 2700      | 600        | 2700      | 1150       | 2700      | 1450       | 2700      | 2600       |

\* For intermediate sizes, the data of the respective next higher standard class apply.

Sizes can be adapted to meet transport requirements. For project-related dimensions, please contact Amiblu.

Amiblu Holding GmbH | Pischeldorfer Str. 128 | 9020 Klagenfurt | Austria | +43 463 482424 | www.amiblu.com | info@amiblu.com

© Amiblu Holding GmbH. Figures may slightly vary due to manufacturing tolerances. Amiblu does not accept any liability for errors, omissions, and subsequent changes to technical data.

# Segmented Elbow PN 1

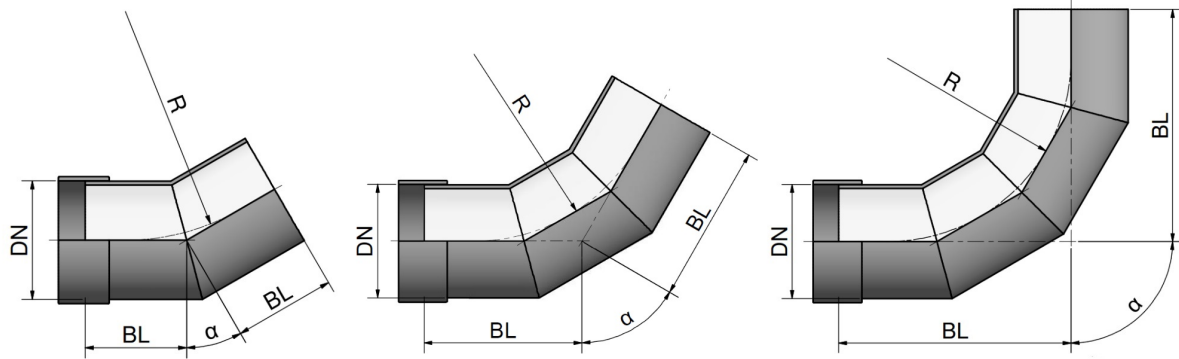

| Angle $\alpha^*$ : |               | 11.25°    |            | 15°       |            | 22.5°     |            | 30°       |            | 45°       |            | 60°       |            | 90°       |            |
|--------------------|---------------|-----------|------------|-----------|------------|-----------|------------|-----------|------------|-----------|------------|-----------|------------|-----------|------------|
| Segments:          |               | 2         |            | 2         |            | 2         |            | 2         |            | 3         |            | 3         |            | 4         |            |
| DN                 | $d_e$<br>[mm] | R<br>[mm] | BL<br>[mm] | R<br>[mm] | BL<br>[mm] | R<br>[mm] | BL<br>[mm] | R<br>[mm] | BL<br>[mm] | R<br>[mm] | BL<br>[mm] | R<br>[mm] | BL<br>[mm] | R<br>[mm] | BL<br>[mm] |
| 1900               | 1943          | 2850      | 650        | 2850      | 650        | 2850      | 650        | 2850      | 650        | 2850      | 1200       | 2850      | 1550       | 2850      | 2750       |
| 2000               | 2045          | 3000      | 650        | 3000      | 650        | 3000      | 650        | 3000      | 650        | 3000      | 1200       | 3000      | 1600       | 3000      | 2850       |
| 2100               | 2147          | 3150      | 650        | 3150      | 650        | 3150      | 650        | 3150      | 650        | 3150      | 1250       | 3150      | 1650       | 3150      | 2950       |
| 2200               | 2249          | 3300      | 700        | 3300      | 700        | 3300      | 700        | 3300      | 700        | 3300      | 1300       | 3300      | 1700       | 3300      | 3100       |
| 2300               | 2351          | 3450      | 700        | 3450      | 700        | 3450      | 700        | 3450      | 700        | 3450      | 1350       | 3450      | 1750       | 3450      | 3200       |
| 2400               | 2453          | 3600      | 700        | 3600      | 700        | 3600      | 700        | 3600      | 700        | 3600      | 1400       | 3600      | 1800       | 3600      | 3350       |
| 2500               | 2555          | 3750      | 750        | 3750      | 750        | 3750      | 750        | 3750      | 750        | 3750      | 1450       | 3750      | 1900       | 3750      | 3450       |
| 2600               | 2657          | 3900      | 750        | 3900      | 750        | 3900      | 750        | 3900      | 750        | 3900      | 1500       | 3900      | 2000       | 3900      | 3650       |
| 2700               | 2759          | 4050      | 800        | 4050      | 800        | 4050      | 800        | 4050      | 800        | 4050      | 1550       | 4050      | 2050       | 4050      | 3750       |
| 2800               | 2861          | 4200      | 800        | 4200      | 800        | 4200      | 800        | 4200      | 800        | 4200      | 1600       | 4200      | 2100       | 4200      | 3900       |
| 2900               | 2963          | 4350      | 800        | 4350      | 800        | 4350      | 800        | 4350      | 800        | 4350      | 1650       | 4350      | 2150       | 4350      | 4000       |
| 3000               | 3065          | 4500      | 850        | 4500      | 850        | 4500      | 850        | 4500      | 850        | 4500      | 1700       | 4500      | 2250       | 4500      | 4150       |
| 3100               | 3167          | 4650      | 850        | 4650      | 850        | 4650      | 850        | 4650      | 850        | 4650      | 1750       | 4650      | 2300       | 4650      | 4300       |
| 3200               | 3269          | 4800      | 900        | 4800      | 900        | 4800      | 900        | 4800      | 900        | 4800      | 1800       | 4800      | 2350       | 4800      | 4400       |

\* For intermediate sizes, the data of the respective next higher standard class apply.

Sizes can be adapted to meet transport requirements. For project-related dimensions, please contact Amiblu.

Amiblu Holding GmbH | Pischeldorfer Str. 128 | 9020 Klagenfurt | Austria | +43 463 482424 | www.amiblu.com | info@amiblu.com

© Amiblu Holding GmbH. Figures may slightly vary due to manufacturing tolerances. Amiblu does not accept any liability for errors, omissions, and subsequent changes to technical data.

# T-Piece Concentric PN 1

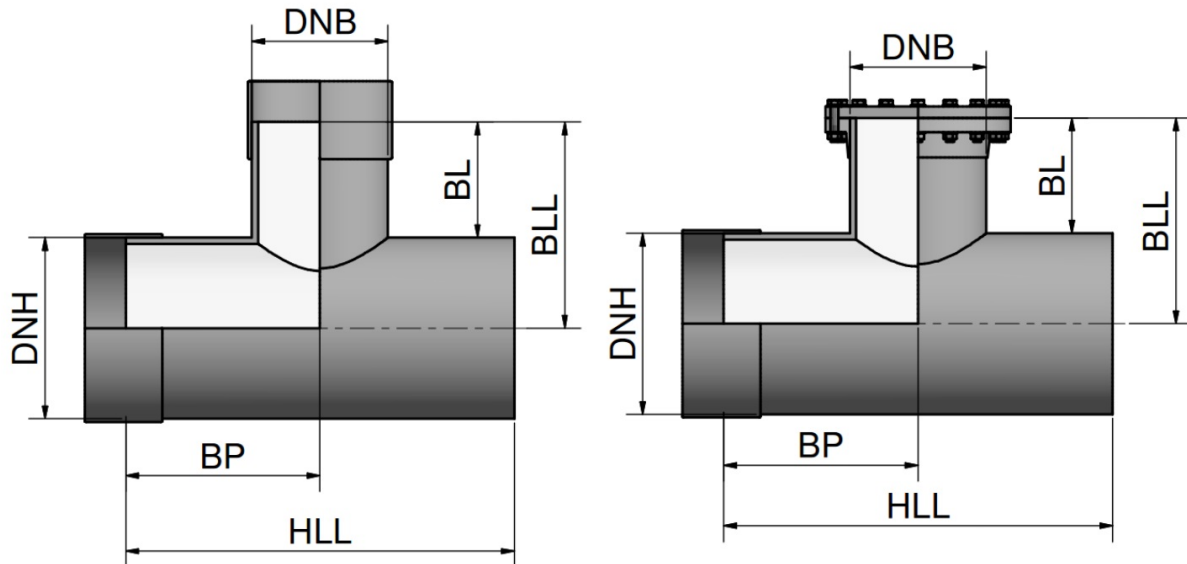

| DN <sub>H</sub> | d <sub>eH</sub><br>[mm] | DN <sub>B</sub> | d <sub>eB</sub><br>[mm] | HLL<br>[mm] | BL<br>[mm] | BLL<br>[mm] | BP<br>[mm] |
|-----------------|-------------------------|-----------------|-------------------------|-------------|------------|-------------|------------|
| 200             | 220                     | 200             | 220                     | 650         | 240        | 350         | 325        |
| 250             | 272                     | 200             | 220                     | 650         | 214        | 350         | 325        |
|                 |                         | 250             | 272                     | 700         | 214        | 350         | 350        |
| 300             | 324                     | 200             | 220                     | 750         | 237        | 400         | 375        |
|                 |                         | 250             | 272                     | 800         | 237        | 400         | 400        |
|                 |                         | 300             | 324                     | 850         | 287        | 450         | 425        |
| 350             | 376                     | 200             | 220                     | 750         | 211        | 400         | 375        |
|                 |                         | 250             | 272                     | 800         | 211        | 400         | 400        |
|                 |                         | 300             | 324                     | 850         | 261        | 450         | 425        |
|                 |                         | 350             | 376                     | 900         | 261        | 450         | 450        |
| 400             | 427                     | 200             | 220                     | 750         | 236        | 450         | 375        |
|                 |                         | 250             | 272                     | 800         | 236        | 450         | 400        |
|                 |                         | 300             | 324                     | 850         | 286        | 500         | 425        |
|                 |                         | 350             | 376                     | 900         | 286        | 500         | 450        |
|                 |                         | 400             | 427                     | 950         | 286        | 500         | 475        |

Table contains selected branch sizes. For our full portfolio, please visit [www.amiblu.com/amiblu-products](http://www.amiblu.com/amiblu-products).  
 Sizes can be adapted to meet transport requirements. For project-related dimensions, please contact Amiblu.

Amiblu Holding GmbH | Pischeldorfer Str. 128 | 9020 Klagenfurt | Austria | +43 463 482424 | [www.amiblu.com](http://www.amiblu.com) | [info@amiblu.com](mailto:info@amiblu.com)

© Amiblu Holding GmbH. Figures may slightly vary due to manufacturing tolerances. Amiblu does not accept any liability for errors, omissions, and subsequent changes to technical data.

# T-Piece Concentric PN 1

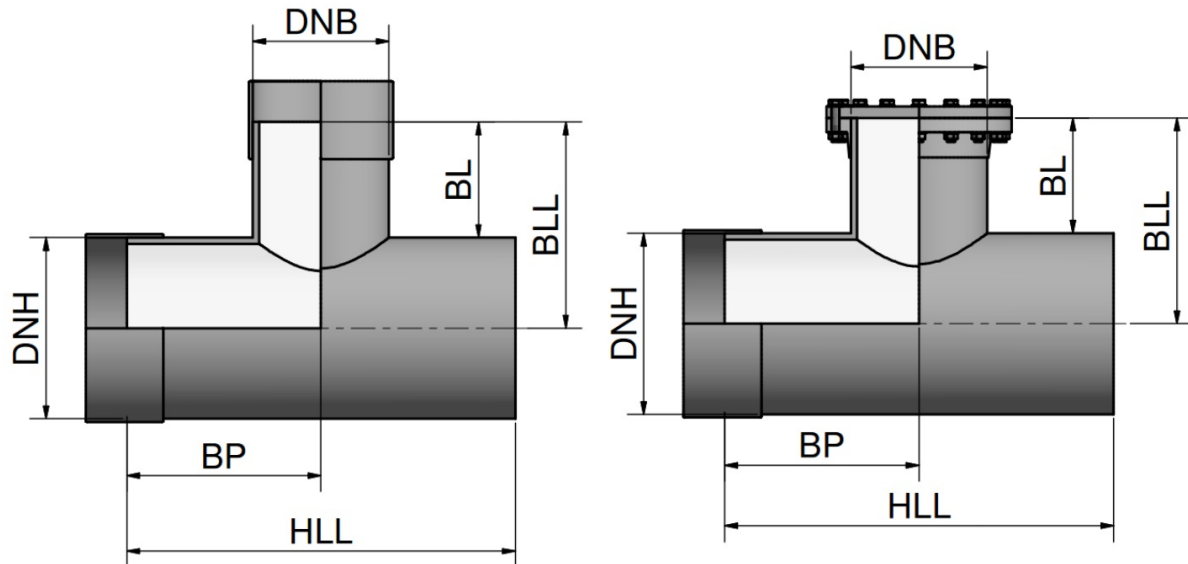

| DN <sub>H</sub> | d <sub>eH</sub><br>[mm] | DN <sub>B</sub> | d <sub>eB</sub><br>[mm] | HLL<br>[mm] | BL<br>[mm] | BLL<br>[mm] | BP<br>[mm] |
|-----------------|-------------------------|-----------------|-------------------------|-------------|------------|-------------|------------|
| 450             | 478                     | 200             | 220                     | 750         | 210        | 450         | 375        |
|                 |                         | 300             | 324                     | 850         | 260        | 500         | 425        |
|                 |                         | 350             | 376                     | 900         | 260        | 500         | 450        |
|                 |                         | 400             | 427                     | 950         | 260        | 500         | 475        |
|                 |                         | 450             | 478                     | 1000        | 260        | 500         | 500        |
| 500             | 530                     | 200             | 220                     | 750         | 234        | 500         | 375        |
|                 |                         | 300             | 324                     | 850         | 284        | 550         | 425        |
|                 |                         | 400             | 427                     | 950         | 284        | 550         | 475        |
|                 |                         | 450             | 478                     | 1000        | 284        | 550         | 500        |
|                 |                         | 500             | 530                     | 1050        | 284        | 550         | 525        |
| 600             | 617                     | 200             | 220                     | 750         | 241        | 550         | 375        |
|                 |                         | 300             | 324                     | 900         | 291        | 600         | 450        |
|                 |                         | 400             | 427                     | 1000        | 291        | 600         | 500        |
|                 |                         | 450             | 478                     | 1050        | 291        | 600         | 525        |
|                 |                         | 600             | 617                     | 1150        | 291        | 600         | 575        |
| 700             | 719                     | 200             | 220                     | 750         | 240        | 600         | 375        |
|                 |                         | 350             | 376                     | 950         | 290        | 650         | 475        |
|                 |                         | 450             | 478                     | 1050        | 290        | 650         | 525        |
|                 |                         | 500             | 530                     | 1100        | 290        | 650         | 550        |
|                 |                         | 700             | 719                     | 1300        | 290        | 650         | 650        |

Table contains selected branch sizes. For our full portfolio, please visit [www.amiblu.com/amiblu-products](http://www.amiblu.com/amiblu-products).

Sizes can be adapted to meet transport requirements. For project-related dimensions, please contact Amiblu.

Amiblu Holding GmbH | Pischeldorfer Str. 128 | 9020 Klagenfurt | Austria | +43 463 482424 | [www.amiblu.com](http://www.amiblu.com) | [info@amiblu.com](mailto:info@amiblu.com)

© Amiblu Holding GmbH. Figures may slightly vary due to manufacturing tolerances. Amiblu does not accept any liability for errors, omissions, and subsequent changes to technical data.

# T-Piece Concentric PN 1

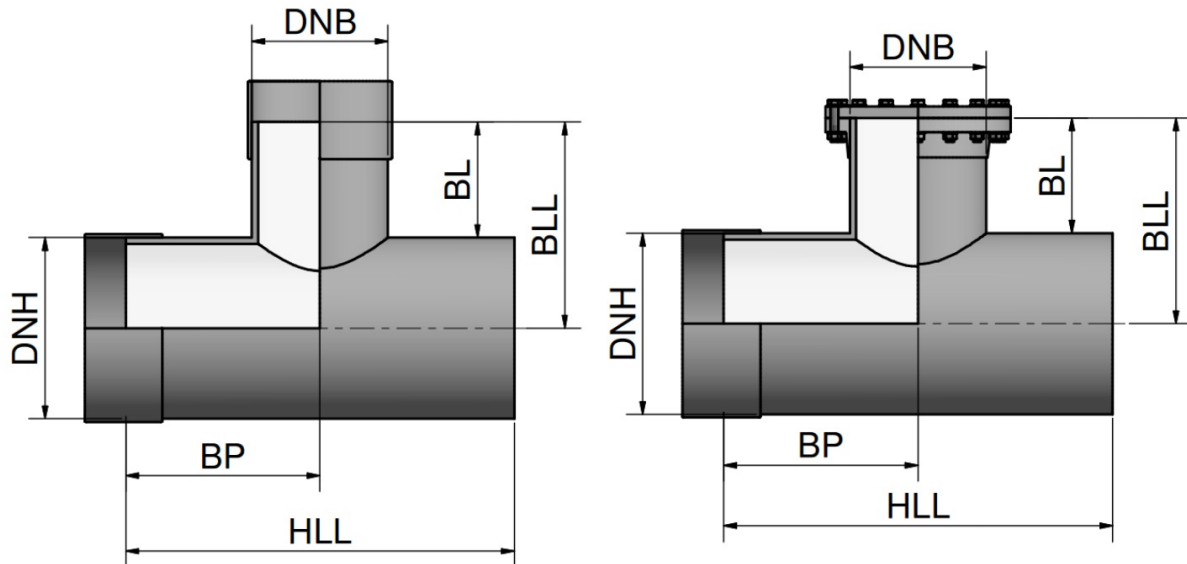

| DN <sub>H</sub> | d <sub>eH</sub><br>[mm] | DN <sub>B</sub> | d <sub>eB</sub><br>[mm] | HLL<br>[mm] | BL<br>[mm] | BLL<br>[mm] | BP<br>[mm] |
|-----------------|-------------------------|-----------------|-------------------------|-------------|------------|-------------|------------|
| 800             | 821                     | 200             | 220                     | 750         | 239        | 650         | 375        |
|                 |                         | 350             | 376                     | 950         | 289        | 700         | 475        |
|                 |                         | 450             | 478                     | 1050        | 289        | 700         | 525        |
|                 |                         | 600             | 617                     | 1150        | 289        | 700         | 575        |
|                 |                         | 800             | 821                     | 1400        | 289        | 700         | 700        |
| 900             | 923                     | 200             | 220                     | 750         | 238        | 700         | 375        |
|                 |                         | 350             | 376                     | 950         | 288        | 750         | 475        |
|                 |                         | 500             | 530                     | 1100        | 288        | 750         | 550        |
|                 |                         | 700             | 719                     | 1300        | 288        | 750         | 650        |
|                 |                         | 900             | 923                     | 1500        | 288        | 750         | 750        |
| 1000            | 1025                    | 200             | 220                     | 750         | 237        | 750         | 375        |
|                 |                         | 350             | 376                     | 950         | 287        | 800         | 475        |
|                 |                         | 500             | 530                     | 1100        | 287        | 800         | 550        |
|                 |                         | 700             | 719                     | 1300        | 287        | 800         | 650        |
|                 |                         | 1000            | 1025                    | 1600        | 287        | 800         | 800        |
| 1100            | 1127                    | 200             | 220                     | 750         | 236        | 800         | 375        |
|                 |                         | 400             | 427                     | 1000        | 286        | 850         | 500        |
|                 |                         | 600             | 617                     | 1150        | 286        | 850         | 575        |
|                 |                         | 800             | 821                     | 1400        | 286        | 850         | 700        |
|                 |                         | 1100            | 1127                    | 1750        | 336        | 900         | 875        |

Table contains selected branch sizes. For our full portfolio, please visit [www.amiblu.com/amiblu-products](http://www.amiblu.com/amiblu-products).

Sizes can be adapted to meet transport requirements. For project-related dimensions, please contact Amiblu.

Amiblu Holding GmbH | Pischeldorfer Str. 128 | 9020 Klagenfurt | Austria | +43 463 482424 | [www.amiblu.com](http://www.amiblu.com) | [info@amiblu.com](mailto:info@amiblu.com)

© Amiblu Holding GmbH. Figures may slightly vary due to manufacturing tolerances. Amiblu does not accept any liability for errors, omissions, and subsequent changes to technical data.

# T-Piece Concentric PN 1

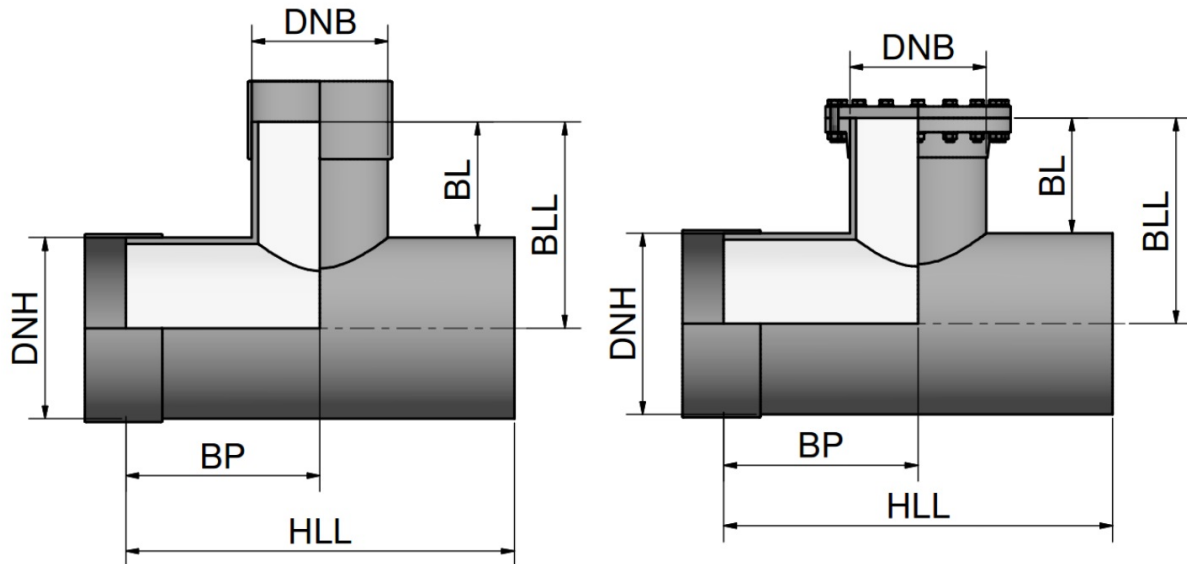

| DN <sub>H</sub> | d <sub>eH</sub><br>[mm] | DN <sub>B</sub> | d <sub>eB</sub><br>[mm] | HLL<br>[mm] | BL<br>[mm] | BLL<br>[mm] | BP<br>[mm] |
|-----------------|-------------------------|-----------------|-------------------------|-------------|------------|-------------|------------|
| 1200            | 1229                    | 200             | 220                     | 750         | 235        | 850         | 375        |
|                 |                         | 400             | 427                     | 1000        | 285        | 900         | 500        |
|                 |                         | 600             | 617                     | 1150        | 285        | 900         | 575        |
|                 |                         | 900             | 923                     | 1500        | 285        | 900         | 750        |
|                 |                         | 1200            | 1229                    | 1850        | 335        | 950         | 925        |
| 1300            | 1331                    | 200             | 220                     | 750         | 234        | 900         | 375        |
|                 |                         | 400             | 427                     | 1000        | 284        | 950         | 500        |
|                 |                         | 700             | 719                     | 1300        | 284        | 950         | 650        |
|                 |                         | 1000            | 1025                    | 1600        | 284        | 950         | 800        |
|                 |                         | 1300            | 1331                    | 1950        | 334        | 1000        | 975        |
| 1400            | 1433                    | 200             | 220                     | 750         | 233        | 950         | 375        |
|                 |                         | 400             | 427                     | 1000        | 283        | 1000        | 500        |
|                 |                         | 700             | 719                     | 1300        | 283        | 1000        | 650        |
|                 |                         | 1000            | 1025                    | 1600        | 283        | 1000        | 800        |
|                 |                         | 1400            | 1433                    | 2050        | 333        | 1050        | 1025       |
| 1500            | 1535                    | 200             | 220                     | 800         | 232        | 1000        | 400        |
|                 |                         | 450             | 478                     | 1050        | 282        | 1050        | 525        |
|                 |                         | 800             | 821                     | 1450        | 282        | 1050        | 725        |
|                 |                         | 1100            | 1127                    | 1750        | 332        | 1100        | 875        |
|                 |                         | 1500            | 1535                    | 2200        | 332        | 1100        | 1100       |

Table contains selected branch sizes. For our full portfolio, please visit [www.amiblu.com/amiblu-products](http://www.amiblu.com/amiblu-products).

Sizes can be adapted to meet transport requirements. For project-related dimensions, please contact Amiblu.

Amiblu Holding GmbH | Pischeldorfer Str. 128 | 9020 Klagenfurt | Austria | +43 463 482424 | [www.amiblu.com](http://www.amiblu.com) | [info@amiblu.com](mailto:info@amiblu.com)

© Amiblu Holding GmbH. Figures may slightly vary due to manufacturing tolerances. Amiblu does not accept any liability for errors, omissions, and subsequent changes to technical data.

# T-Piece Concentric PN 1

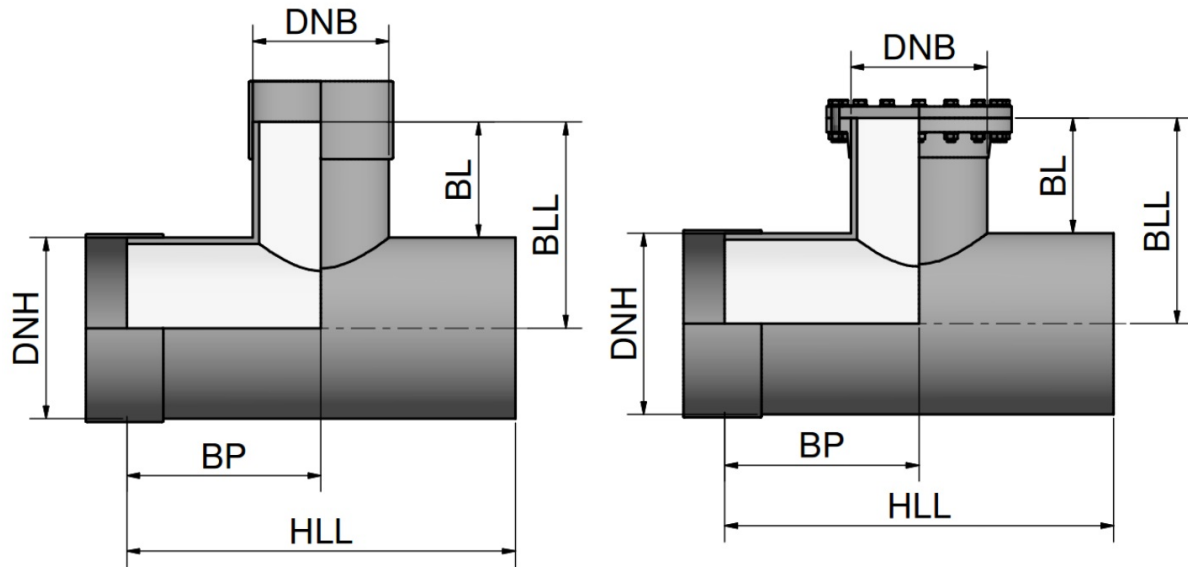

| DN <sub>H</sub> | d <sub>eH</sub><br>[mm] | DN <sub>B</sub> | d <sub>eB</sub><br>[mm] | HLL<br>[mm] | BL<br>[mm] | BLL<br>[mm] | BP<br>[mm] |
|-----------------|-------------------------|-----------------|-------------------------|-------------|------------|-------------|------------|
| 1600            | 1637                    | 200             | 220                     | 800         | 231        | 1050        | 400        |
|                 |                         | 450             | 478                     | 1050        | 281        | 1100        | 525        |
|                 |                         | 800             | 821                     | 1450        | 281        | 1100        | 725        |
|                 |                         | 1200            | 1229                    | 1850        | 331        | 1150        | 925        |
|                 |                         | 1600            | 1637                    | 2300        | 331        | 1150        | 1150       |
| 1700            | 1739                    | 200             | 220                     | 800         | 230        | 1100        | 400        |
|                 |                         | 450             | 478                     | 1050        | 280        | 1150        | 525        |
|                 |                         | 900             | 923                     | 1550        | 280        | 1150        | 775        |
|                 |                         | 1300            | 1331                    | 2000        | 330        | 1200        | 1000       |
|                 |                         | 1700            | 1739                    | 2400        | 330        | 1200        | 1200       |
| 1800            | 1841                    | 200             | 220                     | 800         | 229        | 1150        | 400        |
|                 |                         | 450             | 478                     | 1050        | 279        | 1200        | 525        |
|                 |                         | 900             | 923                     | 1550        | 279        | 1200        | 775        |
|                 |                         | 1300            | 1331                    | 2000        | 329        | 1250        | 1000       |
|                 |                         | 1800            | 1841                    | 2550        | 379        | 1300        | 1275       |
| 1900            | 1943                    | 200             | 220                     | 800         | 228        | 1200        | 400        |
|                 |                         | 500             | 530                     | 1150        | 278        | 1250        | 575        |
|                 |                         | 1000            | 1025                    | 1650        | 278        | 1250        | 825        |
|                 |                         | 1400            | 1433                    | 2100        | 328        | 1300        | 1050       |
|                 |                         | 1900            | 1943                    | 2650        | 378        | 1350        | 1325       |

Table contains selected branch sizes. For our full portfolio, please visit [www.amiblu.com/amiblu-products](http://www.amiblu.com/amiblu-products).

Sizes can be adapted to meet transport requirements. For project-related dimensions, please contact Amiblu.

Amiblu Holding GmbH | Pischeldorfer Str. 128 | 9020 Klagenfurt | Austria | +43 463 482424 | [www.amiblu.com](http://www.amiblu.com) | [info@amiblu.com](mailto:info@amiblu.com)

© Amiblu Holding GmbH. Figures may slightly vary due to manufacturing tolerances. Amiblu does not accept any liability for errors, omissions, and subsequent changes to technical data.



# T-Piece Concentric PN 1

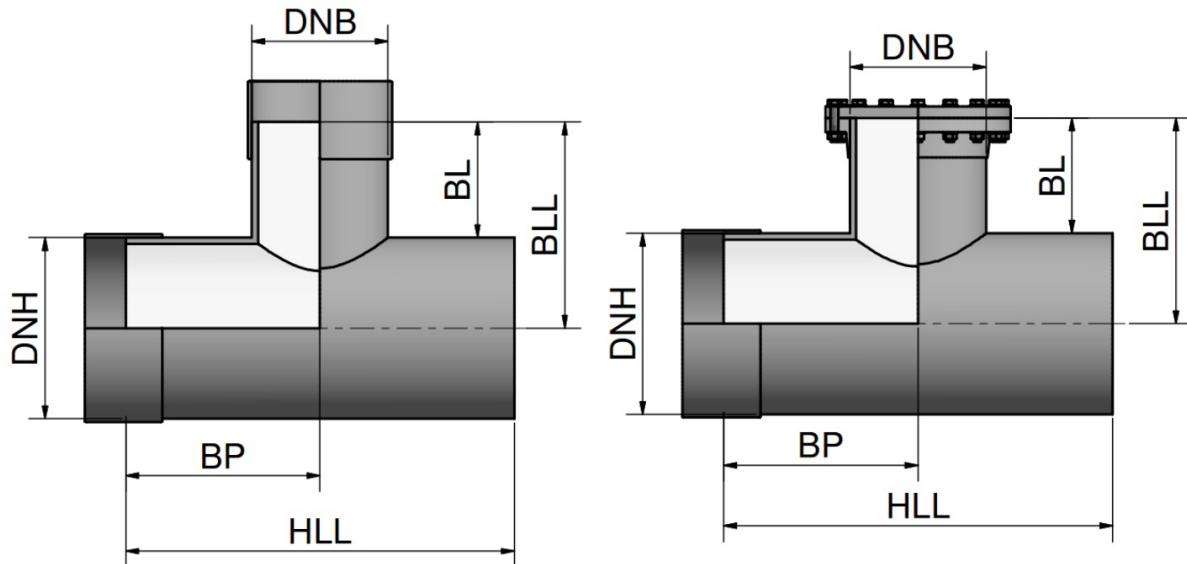

| DN <sub>H</sub> | d <sub>eH</sub> [mm] | DN <sub>B</sub> | d <sub>eB</sub> [mm] | HLL [mm] | BL [mm] | BLL [mm] | BP [mm] |
|-----------------|----------------------|-----------------|----------------------|----------|---------|----------|---------|
| 2000            | 2045                 | 200             | 220                  | 800      | 227     | 1250     | 400     |
|                 |                      | 500             | 530                  | 1150     | 277     | 1300     | 575     |
|                 |                      | 1000            | 1025                 | 1650     | 277     | 1300     | 825     |
|                 |                      | 1500            | 1535                 | 2200     | 327     | 1350     | 1100    |
|                 |                      | 2000            | 2045                 | 2750     | 377     | 1400     | 1375    |
| 2100            | 2147                 | 200             | 220                  | 800      | 226     | 1300     | 400     |
|                 |                      | 500             | 530                  | 1150     | 276     | 1350     | 575     |
|                 |                      | 1100            | 1127                 | 1750     | 326     | 1400     | 875     |
|                 |                      | 1600            | 1637                 | 2300     | 376     | 1450     | 1150    |
|                 |                      | 2100            | 2147                 | 2900     | 376     | 1450     | 1450    |
| 2200            | 2249                 | 200             | 220                  | 800      | 225     | 1350     | 400     |
|                 |                      | 500             | 530                  | 1150     | 275     | 1400     | 575     |
|                 |                      | 1100            | 1127                 | 1750     | 325     | 1450     | 875     |
|                 |                      | 1600            | 1637                 | 2300     | 375     | 1500     | 1150    |
|                 |                      | 2200            | 2249                 | 3000     | 375     | 1500     | 1500    |
| 2300            | 2351                 | 200             | 220                  | 800      | 224     | 1400     | 400     |
|                 |                      | 600             | 617                  | 1200     | 274     | 1450     | 600     |
|                 |                      | 1200            | 1229                 | 1850     | 324     | 1500     | 925     |
|                 |                      | 1700            | 1739                 | 2400     | 374     | 1550     | 1200    |
|                 |                      | 2300            | 2351                 | 3100     | 374     | 1550     | 1550    |

Table contains selected branch sizes. For our full portfolio, please visit [www.amiblu.com/amiblu-products](http://www.amiblu.com/amiblu-products).

Sizes can be adapted to meet transport requirements. For project-related dimensions, please contact Amiblu.

Amiblu Holding GmbH | Pischeldorfer Str. 128 | 9020 Klagenfurt | Austria | +43 463 482424 | [www.amiblu.com](http://www.amiblu.com) | [info@amiblu.com](mailto:info@amiblu.com)

© Amiblu Holding GmbH. Figures may slightly vary due to manufacturing tolerances. Amiblu does not accept any liability for errors, omissions, and subsequent changes to technical data.

# T-Piece Concentric PN 1

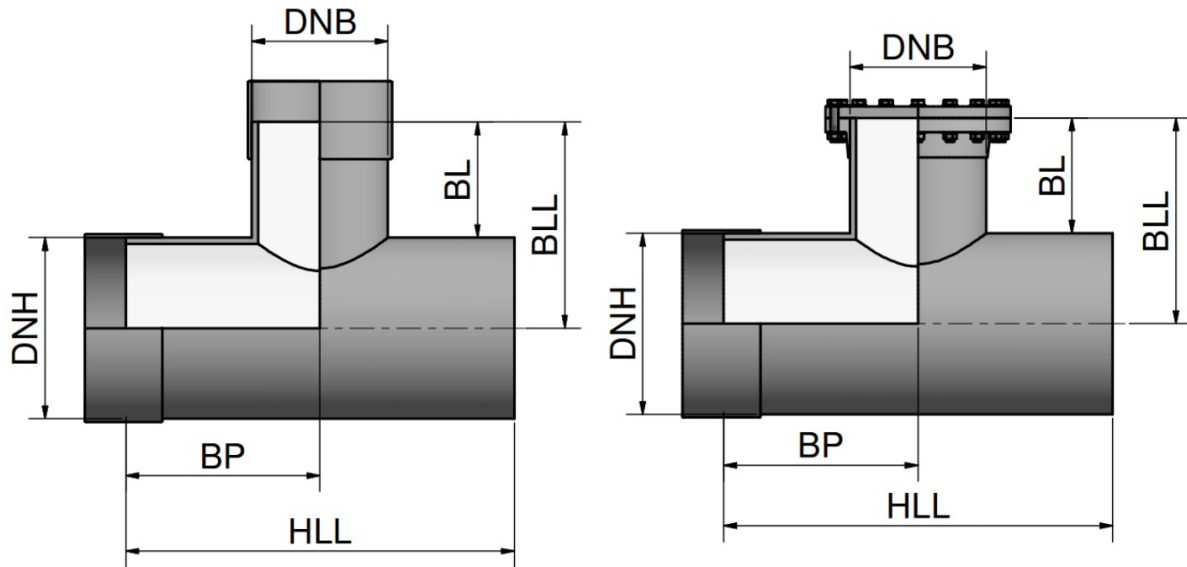

| DN <sub>H</sub> | d <sub>eH</sub><br>[mm] | DN <sub>B</sub> | d <sub>eB</sub><br>[mm] | HLL<br>[mm] | BL<br>[mm] | BLL<br>[mm] | BP<br>[mm] |
|-----------------|-------------------------|-----------------|-------------------------|-------------|------------|-------------|------------|
| 2400            | 2453                    | 200             | 220                     | 800         | 223        | 1450        | 400        |
|                 |                         | 600             | 617                     | 1200        | 273        | 1500        | 600        |
|                 |                         | 1200            | 1229                    | 1850        | 323        | 1550        | 925        |
|                 |                         | 1800            | 1841                    | 2550        | 373        | 1600        | 1275       |
|                 |                         | 2400            | 2453                    | 3200        | 373        | 1600        | 1600       |
| 2500            | 2555                    | 200             | 220                     | 800         | 222        | 1500        | 400        |
|                 |                         | 600             | 617                     | 1200        | 272        | 1550        | 600        |
|                 |                         | 1300            | 1331                    | 2000        | 322        | 1600        | 1000       |
|                 |                         | 1900            | 1943                    | 2650        | 372        | 1650        | 1325       |
|                 |                         | 2500            | 2555                    | 3300        | 372        | 1650        | 1650       |
| 2600            | 2657                    | 200             | 220                     | 850         | 221        | 1550        | 425        |
|                 |                         | 600             | 617                     | 1250        | 271        | 1600        | 625        |
|                 |                         | 1300            | 1331                    | 2000        | 321        | 1650        | 1000       |
|                 |                         | 1900            | 1943                    | 2700        | 371        | 1700        | 1350       |
|                 |                         | 2600            | 2657                    | 3450        | 421        | 1750        | 1725       |
| 2700            | 2759                    | 200             | 220                     | 850         | 220        | 1600        | 425        |
|                 |                         | 700             | 719                     | 1350        | 320        | 1700        | 675        |
|                 |                         | 1400            | 1433                    | 2150        | 320        | 1700        | 1075       |
|                 |                         | 2000            | 2045                    | 2800        | 370        | 1750        | 1400       |
|                 |                         | 2700            | 2759                    | 3550        | 420        | 1800        | 1775       |

Table contains selected branch sizes. For our full portfolio, please visit [www.amiblu.com/amiblu-products](http://www.amiblu.com/amiblu-products).

Sizes can be adapted to meet transport requirements. For project-related dimensions, please contact Amiblu.

Amiblu Holding GmbH | Pischeldorfer Str. 128 | 9020 Klagenfurt | Austria | +43 463 482424 | [www.amiblu.com](http://www.amiblu.com) | [info@amiblu.com](mailto:info@amiblu.com)

© Amiblu Holding GmbH. Figures may slightly vary due to manufacturing tolerances. Amiblu does not accept any liability for errors, omissions, and subsequent changes to technical data.

# T-Piece Concentric PN 1

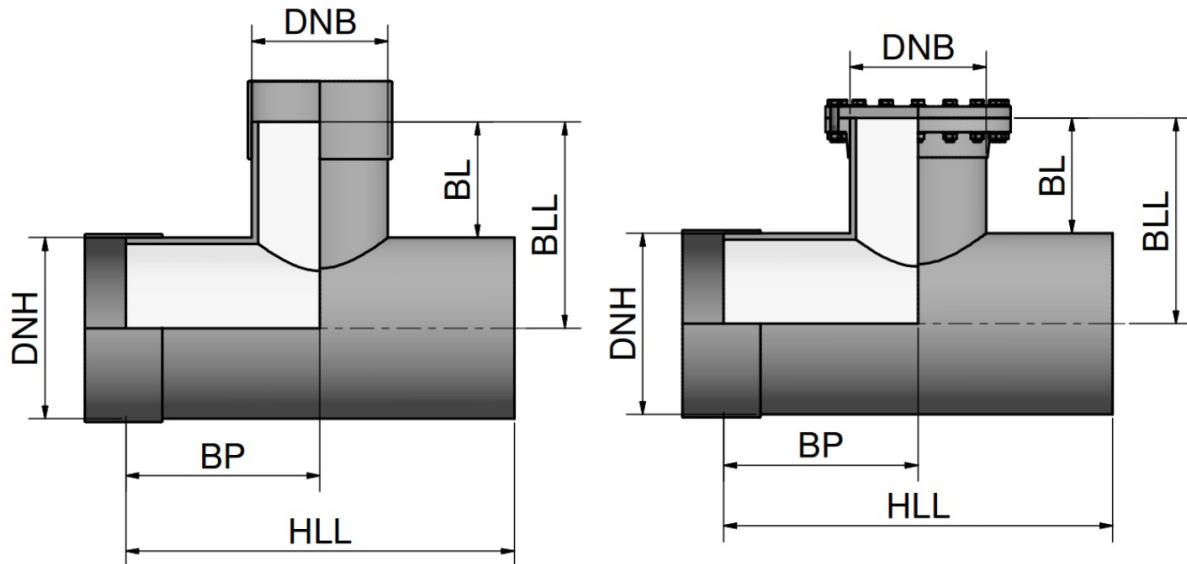

| DN <sub>H</sub> | d <sub>eH</sub><br>[mm] | DN <sub>B</sub> | d <sub>eB</sub><br>[mm] | HLL<br>[mm] | BL<br>[mm] | BLL<br>[mm] | BP<br>[mm] |
|-----------------|-------------------------|-----------------|-------------------------|-------------|------------|-------------|------------|
| 2800            | 2861                    | 200             | 220                     | 850         | 219        | 1650        | 425        |
|                 |                         | 700             | 719                     | 1350        | 319        | 1750        | 675        |
|                 |                         | 1400            | 1433                    | 2150        | 319        | 1750        | 1075       |
|                 |                         | 2100            | 2147                    | 2900        | 369        | 1800        | 1450       |
|                 |                         | 2800            | 2861                    | 3700        | 419        | 1850        | 1850       |
| 2900            | 2963                    | 200             | 220                     | 850         | 218        | 1700        | 425        |
|                 |                         | 700             | 719                     | 1350        | 318        | 1800        | 675        |
|                 |                         | 1500            | 1535                    | 2250        | 368        | 1850        | 1125       |
|                 |                         | 2200            | 2249                    | 3000        | 368        | 1850        | 1500       |
|                 |                         | 2900            | 2963                    | 3800        | 418        | 1900        | 1900       |
| 3000            | 3065                    | 200             | 220                     | 850         | 217        | 1750        | 425        |
|                 |                         | 700             | 719                     | 1350        | 317        | 1850        | 675        |
|                 |                         | 1500            | 1535                    | 2250        | 367        | 1900        | 1125       |
|                 |                         | 2200            | 2249                    | 3000        | 367        | 1900        | 1500       |
|                 |                         | 3000            | 3065                    | 3900        | 417        | 1950        | 1950       |
| 3100            | 3167                    | 200             | 220                     | 850         | 216        | 1800        | 425        |
|                 |                         | 800             | 821                     | 1450        | 316        | 1900        | 725        |
|                 |                         | 1600            | 1637                    | 2350        | 366        | 1950        | 1175       |
|                 |                         | 2300            | 2351                    | 3100        | 366        | 1950        | 1550       |
|                 |                         | 3100            | 3167                    | 4050        | 466        | 2050        | 2025       |

Table contains selected branch sizes. For our full portfolio, please visit [www.amiblu.com/amiblu-products](http://www.amiblu.com/amiblu-products).

Sizes can be adapted to meet transport requirements. For project-related dimensions, please contact Amiblu.

Amiblu Holding GmbH | Pischeldorfer Str. 128 | 9020 Klagenfurt | Austria | +43 463 482424 | [www.amiblu.com](http://www.amiblu.com) | [info@amiblu.com](mailto:info@amiblu.com)

© Amiblu Holding GmbH. Figures may slightly vary due to manufacturing tolerances. Amiblu does not accept any liability for errors, omissions, and subsequent changes to technical data.

# T-Piece Concentric PN 1

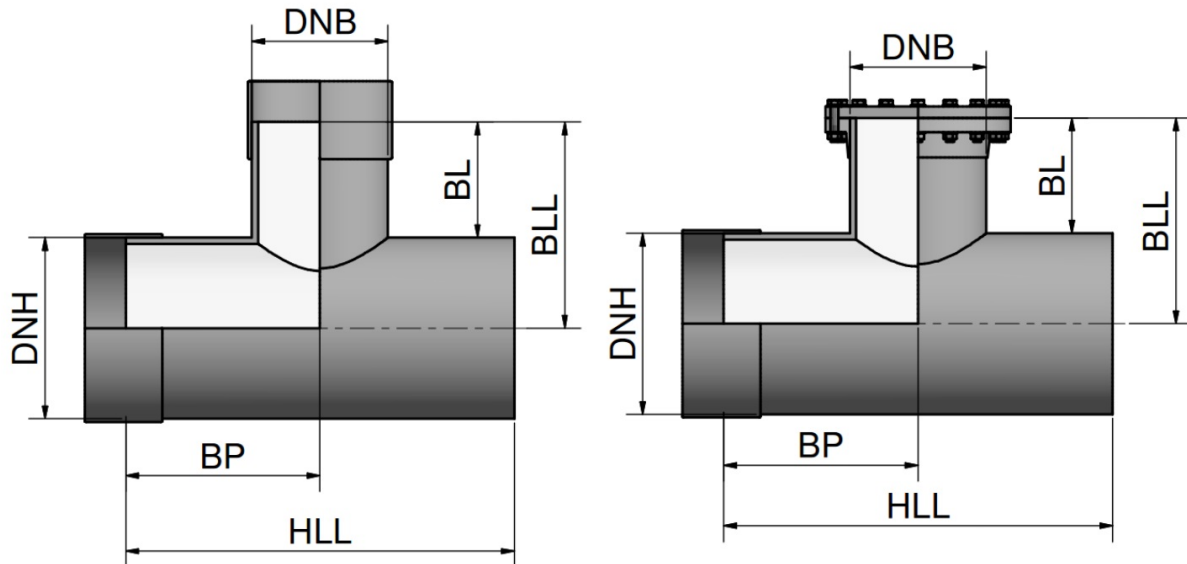

| DN <sub>H</sub> | d <sub>eH</sub><br>[mm] | DN <sub>B</sub> | d <sub>eB</sub><br>[mm] | HLL<br>[mm] | BL<br>[mm] | BLL<br>[mm] | BP<br>[mm] |
|-----------------|-------------------------|-----------------|-------------------------|-------------|------------|-------------|------------|
| 3200            | 3269                    | 200             | 220                     | 850         | 215        | 1850        | 425        |
|                 |                         | 800             | 821                     | 1450        | 315        | 1950        | 725        |
|                 |                         | 1600            | 1637                    | 2350        | 365        | 2000        | 1175       |
|                 |                         | 2400            | 2453                    | 3250        | 415        | 2050        | 1625       |
|                 |                         | 3200            | 3269                    | 4150        | 465        | 2100        | 2075       |

Table contains selected branch sizes. For our full portfolio, please visit [www.amiblu.com/amiblu-products](http://www.amiblu.com/amiblu-products).  
 Sizes can be adapted to meet transport requirements. For project-related dimensions, please contact Amiblu.

Amiblu Holding GmbH | Pischeldorfer Str. 128 | 9020 Klagenfurt | Austria | +43 463 482424 | [www.amiblu.com](http://www.amiblu.com) | [info@amiblu.com](mailto:info@amiblu.com)

© Amiblu Holding GmbH. Figures may slightly vary due to manufacturing tolerances. Amiblu does not accept any liability for errors, omissions, and subsequent changes to technical data.

# T-Piece Eccentric PN 1

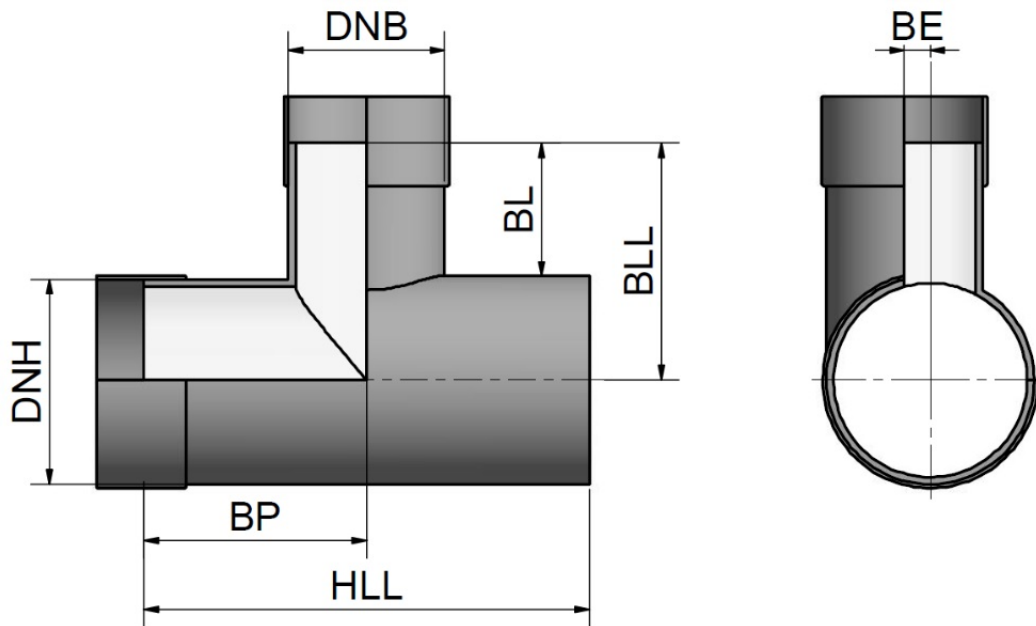

| DN <sub>H</sub> | d <sub>eH</sub><br>[mm] | DN <sub>B</sub> | d <sub>eB</sub><br>[mm] | HLL<br>[mm] | BL<br>[mm] | BLL<br>[mm] | BP<br>[mm] | BE<br>[mm] |
|-----------------|-------------------------|-----------------|-------------------------|-------------|------------|-------------|------------|------------|
| 250             | 272                     | 200             | 220                     | 650         | 214        | 350         | 325        | 26         |
| 300             | 324                     | 200             | 220                     | 750         | 238        | 400         | 375        | 52         |
|                 |                         | 250             | 272                     | 800         | 238        | 400         | 400        | 26         |
| 350             | 376                     | 200             | 220                     | 750         | 212        | 400         | 375        | 78         |
|                 |                         | 250             | 272                     | 800         | 212        | 400         | 400        | 52         |
|                 |                         | 300             | 324                     | 850         | 262        | 450         | 425        | 26         |
| 400             | 427                     | 200             | 220                     | 750         | 236        | 450         | 375        | 104        |
|                 |                         | 250             | 272                     | 800         | 236        | 450         | 400        | 78         |
|                 |                         | 300             | 324                     | 850         | 286        | 500         | 425        | 51         |
|                 |                         | 350             | 376                     | 900         | 286        | 500         | 450        | 25         |
| 450             | 478                     | 200             | 220                     | 750         | 211        | 450         | 375        | 129        |
|                 |                         | 250             | 272                     | 800         | 211        | 450         | 400        | 103        |
|                 |                         | 300             | 324                     | 850         | 261        | 500         | 425        | 77         |
|                 |                         | 350             | 376                     | 900         | 261        | 500         | 450        | 51         |
|                 |                         | 400             | 427                     | 950         | 261        | 500         | 475        | 25         |

Table contains selected branch sizes. For our full portfolio, please visit [www.amiblu.com/amiblu-products](http://www.amiblu.com/amiblu-products).

Sizes can be adapted to meet transport requirements. For project-related dimensions, please contact Amiblu.

Amiblu Holding GmbH | Pischeldorfer Str. 128 | 9020 Klagenfurt | Austria | +43 463 482424 | [www.amiblu.com](http://www.amiblu.com) | [info@amiblu.com](mailto:info@amiblu.com)

© Amiblu Holding GmbH. Figures may slightly vary due to manufacturing tolerances. Amiblu does not accept any liability for errors, omissions, and subsequent changes to technical data.

Publication: 05/2020

# T-Piece Eccentric PN 1

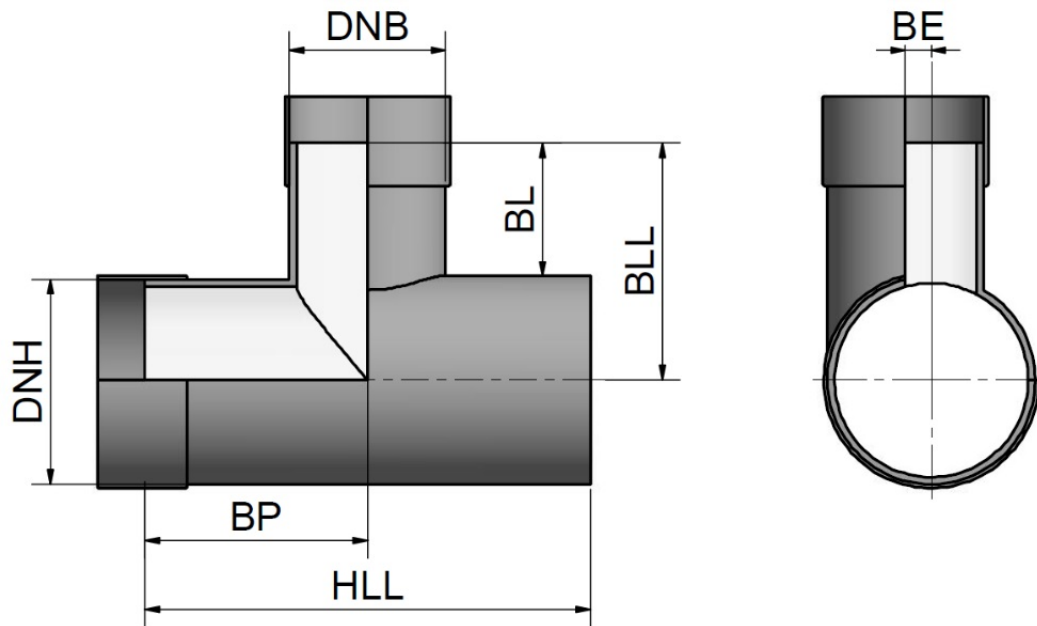

| DN <sub>H</sub> | d <sub>eH</sub><br>[mm] | DN <sub>B</sub> | d <sub>eB</sub><br>[mm] | HLL<br>[mm] | BL<br>[mm] | BLL<br>[mm] | BP<br>[mm] | BE<br>[mm] |
|-----------------|-------------------------|-----------------|-------------------------|-------------|------------|-------------|------------|------------|
| 500             | 530                     | 200             | 220                     | 750         | 235        | 500         | 375        | 155        |
|                 |                         | 300             | 324                     | 850         | 285        | 550         | 425        | 103        |
|                 |                         | 350             | 376                     | 900         | 285        | 550         | 450        | 77         |
|                 |                         | 400             | 427                     | 950         | 285        | 550         | 475        | 51         |
|                 |                         | 450             | 478                     | 1000        | 285        | 550         | 500        | 26         |
| 600             | 617                     | 200             | 220                     | 750         | 241        | 550         | 375        | 198        |
|                 |                         | 300             | 324                     | 900         | 291        | 600         | 450        | 146        |
|                 |                         | 400             | 427                     | 1000        | 291        | 600         | 500        | 95         |
|                 |                         | 450             | 478                     | 1050        | 291        | 600         | 525        | 69         |
|                 |                         | 500             | 530                     | 1100        | 291        | 600         | 550        | 43         |
| 700             | 719                     | 200             | 220                     | 750         | 190        | 550         | 375        | 249        |
|                 |                         | 300             | 324                     | 900         | 290        | 650         | 450        | 197        |
|                 |                         | 400             | 427                     | 1000        | 290        | 650         | 500        | 146        |
|                 |                         | 450             | 478                     | 1050        | 290        | 650         | 525        | 120        |
|                 |                         | 600             | 617                     | 1150        | 290        | 650         | 575        | 51         |
| 800             | 821                     | 200             | 220                     | 750         | 189        | 600         | 375        | 300        |
|                 |                         | 350             | 376                     | 950         | 289        | 700         | 475        | 222        |
|                 |                         | 450             | 478                     | 1050        | 289        | 700         | 525        | 171        |
|                 |                         | 500             | 530                     | 1100        | 289        | 700         | 550        | 145        |
|                 |                         | 700             | 719                     | 1300        | 289        | 700         | 650        | 51         |

Table contains selected branch sizes. For our full portfolio, please visit [www.amiblu.com/amiblu-products](http://www.amiblu.com/amiblu-products).

Sizes can be adapted to meet transport requirements. For project-related dimensions, please contact Amiblu.

Amiblu Holding GmbH | Pischeldorfer Str. 128 | 9020 Klagenfurt | Austria | +43 463 482424 | [www.amiblu.com](http://www.amiblu.com) | [info@amiblu.com](mailto:info@amiblu.com)

© Amiblu Holding GmbH. Figures may slightly vary due to manufacturing tolerances. Amiblu does not accept any liability for errors, omissions, and subsequent changes to technical data.

Publication: 05/2020

# T-Piece Eccentric PN 1

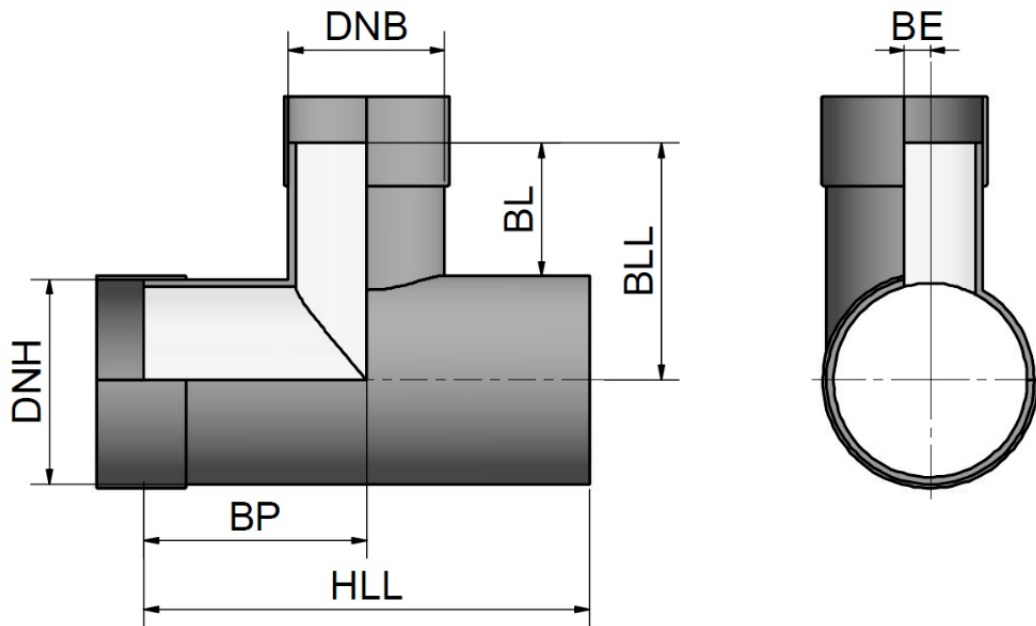

| DN <sub>H</sub> | d <sub>eH</sub><br>[mm] | DN <sub>B</sub> | d <sub>eB</sub><br>[mm] | HLL<br>[mm] | BL<br>[mm] | BLL<br>[mm] | BP<br>[mm] | BE<br>[mm] |
|-----------------|-------------------------|-----------------|-------------------------|-------------|------------|-------------|------------|------------|
| 900             | 923                     | 200             | 220                     | 750         | 188        | 650         | 375        | 351        |
|                 |                         | 350             | 376                     | 950         | 288        | 750         | 475        | 273        |
|                 |                         | 450             | 478                     | 1050        | 288        | 750         | 525        | 222        |
|                 |                         | 600             | 617                     | 1150        | 288        | 750         | 575        | 153        |
|                 |                         | 800             | 821                     | 1400        | 288        | 750         | 700        | 51         |
| 1000            | 1025                    | 200             | 220                     | 750         | 137        | 650         | 375        | 402        |
|                 |                         | 350             | 376                     | 950         | 237        | 750         | 475        | 324        |
|                 |                         | 500             | 530                     | 1100        | 287        | 800         | 550        | 247        |
|                 |                         | 700             | 719                     | 1300        | 287        | 800         | 650        | 153        |
|                 |                         | 900             | 923                     | 1500        | 287        | 800         | 750        | 51         |
| 1100            | 1127                    | 200             | 220                     | 750         | 136        | 700         | 375        | 453        |
|                 |                         | 350             | 376                     | 950         | 236        | 800         | 475        | 375        |
|                 |                         | 500             | 530                     | 1100        | 286        | 850         | 550        | 298        |
|                 |                         | 700             | 719                     | 1300        | 286        | 850         | 650        | 204        |
|                 |                         | 1000            | 1025                    | 1600        | 286        | 850         | 800        | 51         |
| 1200            | 1229                    | 200             | 220                     | 750         | 85         | 700         | 375        | 504        |
|                 |                         | 400             | 427                     | 1000        | 235        | 850         | 500        | 401        |
|                 |                         | 600             | 617                     | 1150        | 285        | 900         | 575        | 306        |
|                 |                         | 800             | 821                     | 1400        | 285        | 900         | 700        | 204        |
|                 |                         | 1100            | 1127                    | 1750        | 335        | 950         | 875        | 51         |

Table contains selected branch sizes. For our full portfolio, please visit [www.amiblu.com/amiblu-products](http://www.amiblu.com/amiblu-products).

Sizes can be adapted to meet transport requirements. For project-related dimensions, please contact Amiblu.

Amiblu Holding GmbH | Pischeldorfer Str. 128 | 9020 Klagenfurt | Austria | +43 463 482424 | [www.amiblu.com](http://www.amiblu.com) | [info@amiblu.com](mailto:info@amiblu.com)

© Amiblu Holding GmbH. Figures may slightly vary due to manufacturing tolerances. Amiblu does not accept any liability for errors, omissions, and subsequent changes to technical data.

# T-Piece Eccentric PN 1

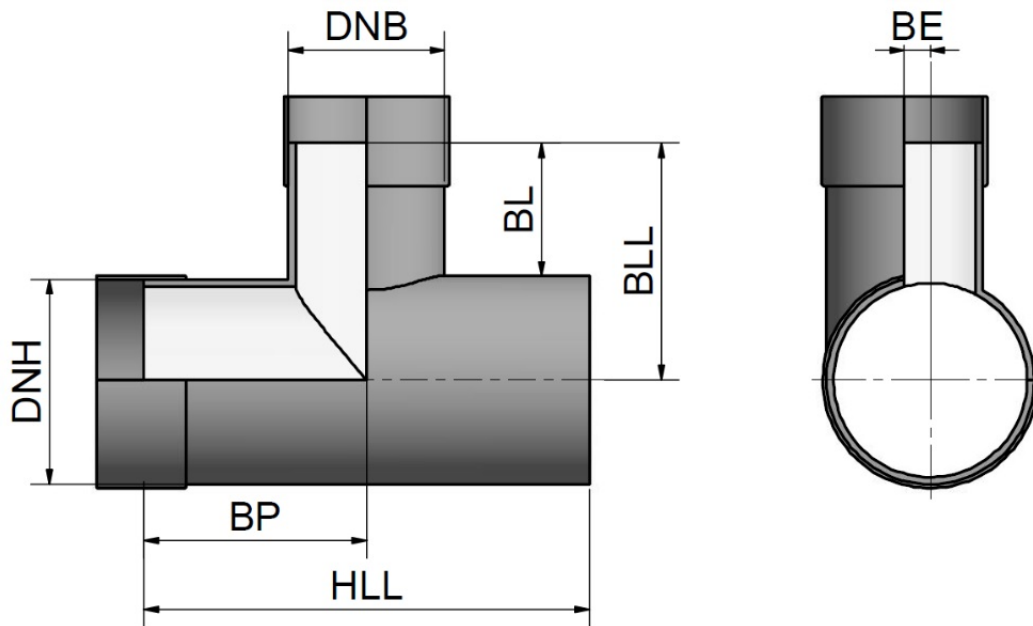

| DN <sub>H</sub> | d <sub>eH</sub><br>[mm] | DN <sub>B</sub> | d <sub>eB</sub><br>[mm] | HLL<br>[mm] | BL<br>[mm] | BLL<br>[mm] | BP<br>[mm] | BE<br>[mm] |
|-----------------|-------------------------|-----------------|-------------------------|-------------|------------|-------------|------------|------------|
| 1300            | 1331                    | 200             | 220                     | 750         | 84         | 750         | 375        | 555        |
|                 |                         | 400             | 427                     | 1000        | 234        | 900         | 500        | 452        |
|                 |                         | 600             | 617                     | 1150        | 284        | 950         | 575        | 357        |
|                 |                         | 900             | 923                     | 1500        | 284        | 950         | 750        | 204        |
|                 |                         | 1200            | 1229                    | 1850        | 334        | 1000        | 925        | 51         |
| 1400            | 1433                    | 200             | 220                     | 750         | 33         | 750         | 375        | 606        |
|                 |                         | 400             | 427                     | 1000        | 233        | 950         | 500        | 503        |
|                 |                         | 700             | 719                     | 1300        | 283        | 1000        | 650        | 357        |
|                 |                         | 1000            | 1025                    | 1600        | 283        | 1000        | 800        | 204        |
|                 |                         | 1300            | 1331                    | 1950        | 333        | 1050        | 975        | 51         |
| 1500            | 1535                    | 250             | 272                     | 850         | 32         | 800         | 425        | 631        |
|                 |                         | 450             | 478                     | 1050        | 232        | 1000        | 525        | 528        |
|                 |                         | 800             | 821                     | 1450        | 282        | 1050        | 725        | 357        |
|                 |                         | 1100            | 1127                    | 1750        | 332        | 1100        | 875        | 204        |
|                 |                         | 1400            | 1433                    | 2100        | 332        | 1100        | 1050       | 51         |
| 1600            | 1637                    | 250             | 272                     | 850         | 31         | 850         | 425        | 682        |
|                 |                         | 450             | 478                     | 1050        | 181        | 1000        | 525        | 579        |
|                 |                         | 800             | 821                     | 1450        | 281        | 1100        | 725        | 408        |
|                 |                         | 1100            | 1127                    | 1750        | 331        | 1150        | 875        | 255        |
|                 |                         | 1500            | 1535                    | 2200        | 331        | 1150        | 1100       | 51         |

Table contains selected branch sizes. For our full portfolio, please visit [www.amiblu.com/amiblu-products](http://www.amiblu.com/amiblu-products).

Sizes can be adapted to meet transport requirements. For project-related dimensions, please contact Amiblu.

Amiblu Holding GmbH | Pischeldorfer Str. 128 | 9020 Klagenfurt | Austria | +43 463 482424 | [www.amiblu.com](http://www.amiblu.com) | [info@amiblu.com](mailto:info@amiblu.com)

© Amiblu Holding GmbH. Figures may slightly vary due to manufacturing tolerances. Amiblu does not accept any liability for errors, omissions, and subsequent changes to technical data.



# T-Piece Eccentric PN 1

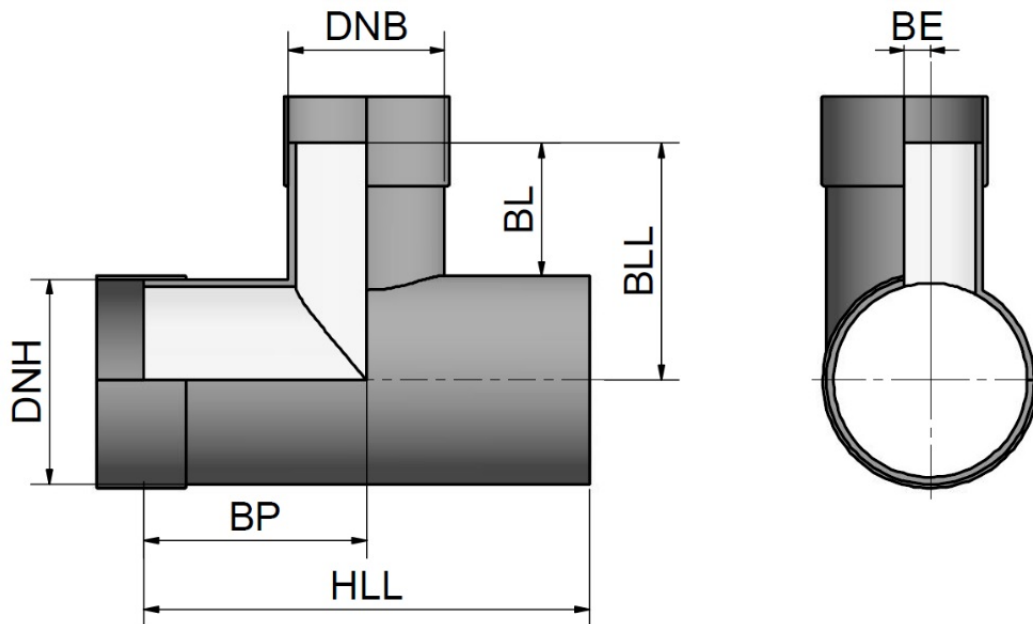

| DN <sub>H</sub> | d <sub>eH</sub><br>[mm] | DN <sub>B</sub> | d <sub>eB</sub><br>[mm] | HLL<br>[mm] | BL<br>[mm] | BLL<br>[mm] | BP<br>[mm] | BE<br>[mm] |
|-----------------|-------------------------|-----------------|-------------------------|-------------|------------|-------------|------------|------------|
| 1700            | 1739                    | 300             | 324                     | 900         | 80         | 950         | 450        | 707        |
|                 |                         | 500             | 530                     | 1150        | 230        | 1100        | 575        | 604        |
|                 |                         | 900             | 923                     | 1550        | 280        | 1150        | 775        | 408        |
|                 |                         | 1200            | 1229                    | 1850        | 330        | 1200        | 925        | 255        |
|                 |                         | 1600            | 1637                    | 2300        | 330        | 1200        | 1150       | 51         |
| 1800            | 1841                    | 300             | 324                     | 900         | 79         | 1000        | 450        | 758        |
|                 |                         | 600             | 617                     | 1200        | 229        | 1150        | 600        | 612        |
|                 |                         | 1000            | 1025                    | 1650        | 279        | 1200        | 825        | 408        |
|                 |                         | 1300            | 1331                    | 2000        | 329        | 1250        | 1000       | 255        |
|                 |                         | 1700            | 1739                    | 2400        | 329        | 1250        | 1200       | 51         |
| 1900            | 1943                    | 300             | 324                     | 900         | 28         | 1000        | 450        | 809        |
|                 |                         | 600             | 617                     | 1200        | 228        | 1200        | 600        | 663        |
|                 |                         | 1000            | 1025                    | 1650        | 278        | 1250        | 825        | 459        |
|                 |                         | 1400            | 1433                    | 2100        | 328        | 1300        | 1050       | 255        |
|                 |                         | 1800            | 1841                    | 2550        | 378        | 1350        | 1275       | 51         |
| 2000            | 2045                    | 350             | 376                     | 950         | 27         | 1050        | 475        | 834        |
|                 |                         | 700             | 719                     | 1350        | 227        | 1250        | 675        | 663        |
|                 |                         | 1100            | 1127                    | 1750        | 327        | 1350        | 875        | 459        |
|                 |                         | 1500            | 1535                    | 2200        | 327        | 1350        | 1100       | 255        |
|                 |                         | 1900            | 1943                    | 2650        | 377        | 1400        | 1325       | 51         |

Table contains selected branch sizes. For our full portfolio, please visit [www.amiblu.com/amiblu-products](http://www.amiblu.com/amiblu-products).  
 Sizes can be adapted to meet transport requirements. For project-related dimensions, please contact Amiblu.

Amiblu Holding GmbH | Pischeldorfer Str. 128 | 9020 Klagenfurt | Austria | +43 463 482424 | [www.amiblu.com](http://www.amiblu.com) | [info@amiblu.com](mailto:info@amiblu.com)

© Amiblu Holding GmbH. Figures may slightly vary due to manufacturing tolerances. Amiblu does not accept any liability for errors, omissions, and subsequent changes to technical data.

# T-Piece Eccentric PN 1

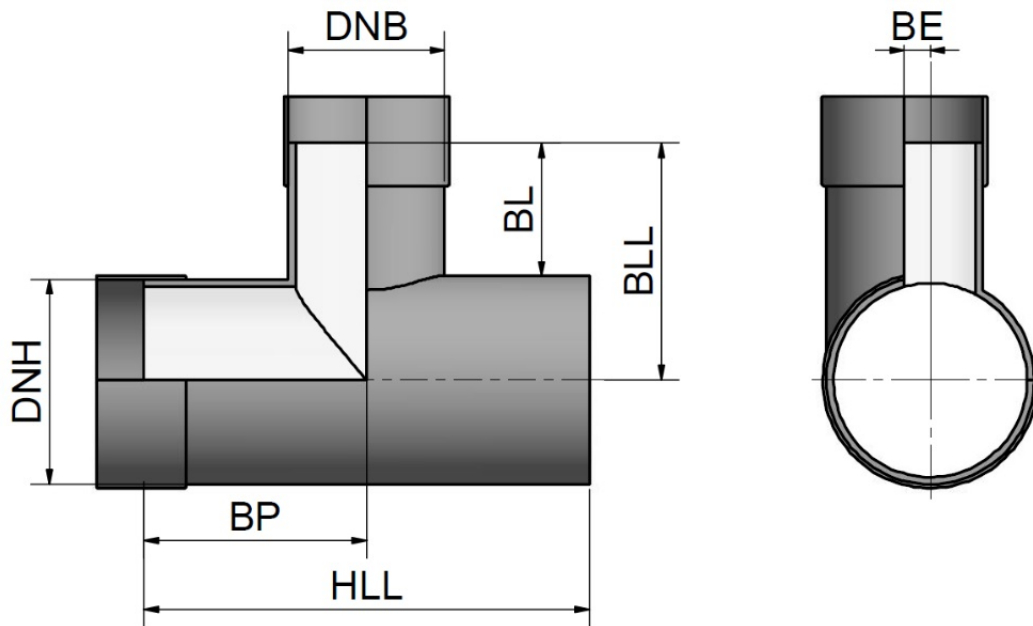

| DN <sub>H</sub> | d <sub>eH</sub><br>[mm] | DN <sub>B</sub> | d <sub>eB</sub><br>[mm] | HLL<br>[mm] | BL<br>[mm] | BLL<br>[mm] | BP<br>[mm] | BE<br>[mm] |
|-----------------|-------------------------|-----------------|-------------------------|-------------|------------|-------------|------------|------------|
| 2100            | 2147                    | 350             | 376                     | 950         | 26         | 1100        | 475        | 885        |
|                 |                         | 700             | 719                     | 1350        | 226        | 1300        | 675        | 714        |
|                 |                         | 1200            | 1229                    | 1850        | 326        | 1400        | 925        | 459        |
|                 |                         | 1600            | 1637                    | 2300        | 376        | 1450        | 1150       | 255        |
|                 |                         | 2000            | 2045                    | 2750        | 376        | 1450        | 1375       | 51         |
| 2200            | 2249                    | 400             | 427                     | 1000        | 25         | 1150        | 500        | 911        |
|                 |                         | 800             | 821                     | 1450        | 275        | 1400        | 725        | 714        |
|                 |                         | 1300            | 1331                    | 2000        | 325        | 1450        | 1000       | 459        |
|                 |                         | 1700            | 1739                    | 2400        | 375        | 1500        | 1200       | 255        |
|                 |                         | 2100            | 2147                    | 2900        | 375        | 1500        | 1450       | 51         |
| 2300            | 2351                    | 400             | 427                     | 1000        | 24         | 1200        | 500        | 962        |
|                 |                         | 800             | 821                     | 1450        | 224        | 1400        | 725        | 765        |
|                 |                         | 1300            | 1331                    | 2000        | 324        | 1500        | 1000       | 510        |
|                 |                         | 1700            | 1739                    | 2400        | 374        | 1550        | 1200       | 306        |
|                 |                         | 2200            | 2249                    | 3000        | 374        | 1550        | 1500       | 51         |
| 2400            | 2453                    | 450             | 478                     | 1050        | 23         | 1250        | 525        | 987        |
|                 |                         | 900             | 923                     | 1550        | 273        | 1500        | 775        | 765        |
|                 |                         | 1400            | 1433                    | 2100        | 323        | 1550        | 1050       | 510        |
|                 |                         | 1800            | 1841                    | 2550        | 373        | 1600        | 1275       | 306        |
|                 |                         | 2300            | 2351                    | 3100        | 373        | 1600        | 1550       | 51         |

Table contains selected branch sizes. For our full portfolio, please visit [www.amiblu.com/amiblu-products](http://www.amiblu.com/amiblu-products).

Sizes can be adapted to meet transport requirements. For project-related dimensions, please contact Amiblu.

Amiblu Holding GmbH | Pischeldorfer Str. 128 | 9020 Klagenfurt | Austria | +43 463 482424 | [www.amiblu.com](http://www.amiblu.com) | [info@amiblu.com](mailto:info@amiblu.com)

© Amiblu Holding GmbH. Figures may slightly vary due to manufacturing tolerances. Amiblu does not accept any liability for errors, omissions, and subsequent changes to technical data.

# T-Piece Eccentric PN 1

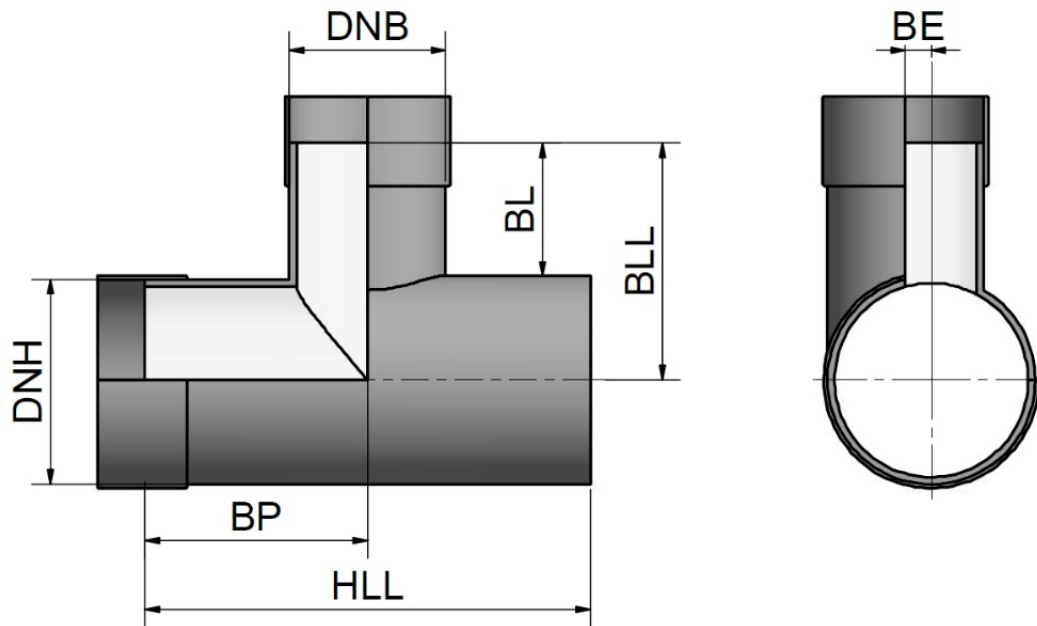

| DN <sub>H</sub> | d <sub>eH</sub><br>[mm] | DN <sub>B</sub> | d <sub>eB</sub><br>[mm] | HLL<br>[mm] | BL<br>[mm] | BLL<br>[mm] | BP<br>[mm] | BE<br>[mm] |
|-----------------|-------------------------|-----------------|-------------------------|-------------|------------|-------------|------------|------------|
| 2500            | 2555                    | 500             | 530                     | 1150        | 22         | 1300        | 575        | 1012       |
|                 |                         | 1000            | 1025                    | 1650        | 272        | 1550        | 825        | 765        |
|                 |                         | 1500            | 1535                    | 2200        | 372        | 1650        | 1100       | 510        |
|                 |                         | 1900            | 1943                    | 2650        | 372        | 1650        | 1325       | 306        |
|                 |                         | 2400            | 2453                    | 3200        | 372        | 1650        | 1600       | 51         |
| 2600            | 2657                    | 500             | 530                     | 1150        | 21         | 1350        | 575        | 1063       |
|                 |                         | 1100            | 1127                    | 1800        | 321        | 1650        | 900        | 765        |
|                 |                         | 1600            | 1637                    | 2350        | 371        | 1700        | 1175       | 510        |
|                 |                         | 2000            | 2045                    | 2800        | 371        | 1700        | 1400       | 306        |
|                 |                         | 2500            | 2555                    | 3350        | 371        | 1700        | 1675       | 51         |
| 2700            | 2759                    | 600             | 617                     | 1250        | 70         | 1450        | 625        | 1071       |
|                 |                         | 1200            | 1229                    | 1900        | 320        | 1700        | 950        | 765        |
|                 |                         | 1700            | 1739                    | 2450        | 370        | 1750        | 1225       | 510        |
|                 |                         | 2100            | 2147                    | 2900        | 370        | 1750        | 1450       | 306        |
|                 |                         | 2600            | 2657                    | 3450        | 420        | 1800        | 1725       | 51         |
| 2800            | 2861                    | 600             | 617                     | 1250        | 19         | 1450        | 625        | 1122       |
|                 |                         | 1200            | 1229                    | 1900        | 319        | 1750        | 950        | 816        |
|                 |                         | 1700            | 1739                    | 2450        | 369        | 1800        | 1225       | 561        |
|                 |                         | 2200            | 2249                    | 3000        | 369        | 1800        | 1500       | 306        |
|                 |                         | 2700            | 2759                    | 3550        | 419        | 1850        | 1775       | 51         |

Table contains selected branch sizes. For our full portfolio, please visit [www.amiblu.com/amiblu-products](http://www.amiblu.com/amiblu-products).

Sizes can be adapted to meet transport requirements. For project-related dimensions, please contact Amiblu.

Amiblu Holding GmbH | Pischeldorfer Str. 128 | 9020 Klagenfurt | Austria | +43 463 482424 | [www.amiblu.com](http://www.amiblu.com) | [info@amiblu.com](mailto:info@amiblu.com)

© Amiblu Holding GmbH. Figures may slightly vary due to manufacturing tolerances. Amiblu does not accept any liability for errors, omissions, and subsequent changes to technical data.

# T-Piece Eccentric PN 1

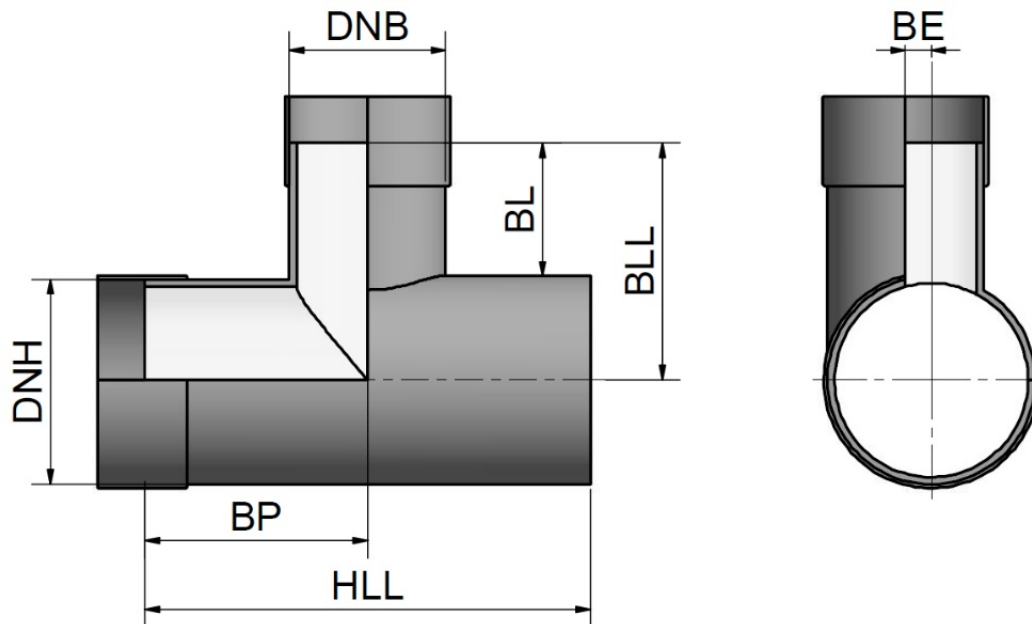

| DN <sub>H</sub> | d <sub>eH</sub><br>[mm] | DN <sub>B</sub> | d <sub>eB</sub><br>[mm] | HLL<br>[mm] | BL<br>[mm] | BLL<br>[mm] | BP<br>[mm] | BE<br>[mm] |
|-----------------|-------------------------|-----------------|-------------------------|-------------|------------|-------------|------------|------------|
| 2900            | 2963                    | 600             | 617                     | 1250        | 18         | 1500        | 625        | 1173       |
|                 |                         | 1200            | 1229                    | 1900        | 268        | 1750        | 950        | 867        |
|                 |                         | 1800            | 1841                    | 2550        | 368        | 1850        | 1275       | 561        |
|                 |                         | 2300            | 2351                    | 3100        | 368        | 1850        | 1550       | 306        |
|                 |                         | 2800            | 2861                    | 3700        | 418        | 1900        | 1850       | 51         |
| 3000            | 3065                    | 700             | 719                     | 1350        | 67         | 1600        | 675        | 1173       |
|                 |                         | 1300            | 1331                    | 2000        | 317        | 1850        | 1000       | 867        |
|                 |                         | 1900            | 1943                    | 2700        | 367        | 1900        | 1350       | 561        |
|                 |                         | 2400            | 2453                    | 3250        | 417        | 1950        | 1625       | 306        |
|                 |                         | 2900            | 2963                    | 3800        | 417        | 1950        | 1900       | 51         |
| 3100            | 3167                    | 700             | 719                     | 1350        | 16         | 1600        | 675        | 1224       |
|                 |                         | 1300            | 1331                    | 2000        | 316        | 1900        | 1000       | 918        |
|                 |                         | 1900            | 1943                    | 2700        | 366        | 1950        | 1350       | 612        |
|                 |                         | 2400            | 2453                    | 3250        | 416        | 2000        | 1625       | 357        |
|                 |                         | 3000            | 3065                    | 3900        | 416        | 2000        | 1950       | 51         |
| 3200            | 3269                    | 700             | 719                     | 1350        | 15         | 1650        | 675        | 1275       |
|                 |                         | 1400            | 1433                    | 2150        | 315        | 1950        | 1075       | 918        |
|                 |                         | 2000            | 2045                    | 2800        | 365        | 2000        | 1400       | 612        |
|                 |                         | 2500            | 2555                    | 3350        | 415        | 2050        | 1675       | 357        |
|                 |                         | 3100            | 3167                    | 4050        | 465        | 2100        | 2025       | 51         |

Table contains selected branch sizes. For our full portfolio, please visit [www.amiblu.com/amiblu-products](http://www.amiblu.com/amiblu-products).

Sizes can be adapted to meet transport requirements. For project-related dimensions, please contact Amiblu.

Amiblu Holding GmbH | Pischeldorfer Str. 128 | 9020 Klagenfurt | Austria | +43 463 482424 | [www.amiblu.com](http://www.amiblu.com) | [info@amiblu.com](mailto:info@amiblu.com)

© Amiblu Holding GmbH. Figures may slightly vary due to manufacturing tolerances. Amiblu does not accept any liability for errors, omissions, and subsequent changes to technical data.

# Reducer PN 1

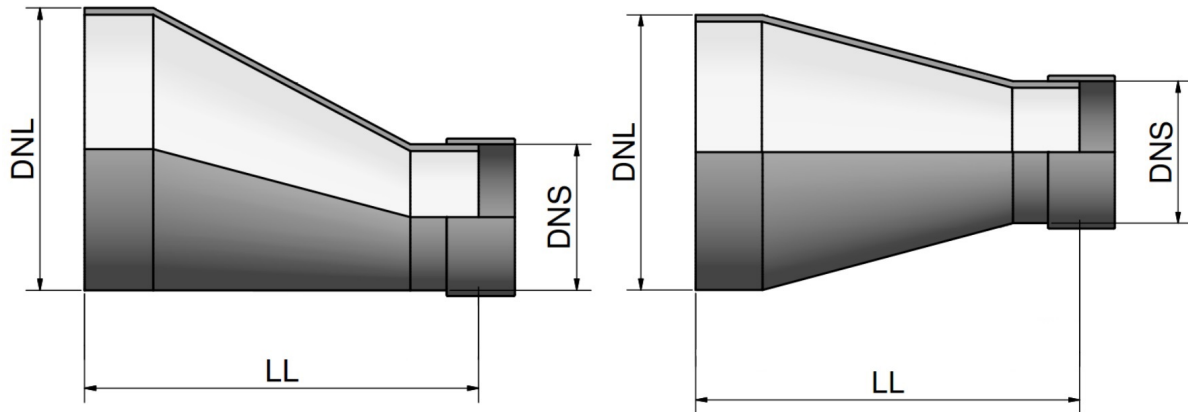

| DN <sub>L</sub> | d <sub>eL</sub><br>[mm] | DN <sub>S</sub> | d <sub>eS</sub><br>[mm] | LL<br>[mm] | DN <sub>S</sub> | d <sub>eS</sub><br>[mm] | LL<br>[mm] | DN <sub>S</sub> | d <sub>eS</sub><br>[mm] | LL<br>[mm] | DN <sub>S</sub> | d <sub>eS</sub><br>[mm] | LL<br>[mm] |
|-----------------|-------------------------|-----------------|-------------------------|------------|-----------------|-------------------------|------------|-----------------|-------------------------|------------|-----------------|-------------------------|------------|
| 250             | 272                     | 200             | 220                     | 725        | -               | -                       | -          | -               | -                       | -          | -               | -                       | -          |
| 300             | 324                     | 250             | 272                     | 925        | 200             | 220                     | 1050       | -               | -                       | -          | -               | -                       | -          |
| 350             | 376                     | 300             | 324                     | 925        | 250             | 272                     | 1050       | 200             | 220                     | 1175       | -               | -                       | -          |
| 400             | 427                     | 350             | 376                     | 925        | 300             | 324                     | 1050       | 250             | 272                     | 1175       | 200             | 220                     | 1300       |
| 450             | 478                     | 400             | 427                     | 925        | 350             | 376                     | 1050       | 300             | 324                     | 1175       | 250             | 272                     | 1300       |
| 500             | 530                     | 450             | 478                     | 925        | 400             | 427                     | 1050       | 350             | 376                     | 1175       | 300             | 324                     | 1300       |
| 600             | 617                     | 500             | 530                     | 1050       | 450             | 478                     | 1175       | 400             | 427                     | 1300       | 350             | 376                     | 1425       |
| 700             | 719                     | 600             | 617                     | 1050       | 500             | 530                     | 1300       | 450             | 478                     | 1425       | 400             | 427                     | 1550       |
| 800             | 821                     | 700             | 719                     | 1050       | 600             | 617                     | 1300       | 500             | 530                     | 1550       | 450             | 478                     | 1675       |
| 900             | 923                     | 800             | 821                     | 1050       | 700             | 719                     | 1300       | 600             | 617                     | 1550       | 500             | 530                     | 1800       |
| 1000            | 1025                    | 900             | 923                     | 1050       | 800             | 821                     | 1300       | 700             | 719                     | 1550       | 600             | 617                     | 1800       |
| 1100            | 1127                    | 1000            | 1025                    | 1050       | 900             | 923                     | 1300       | 800             | 821                     | 1550       | 700             | 719                     | 1800       |
| 1200            | 1229                    | 1100            | 1127                    | 1050       | 1000            | 1025                    | 1300       | 900             | 923                     | 1550       | 800             | 821                     | 1800       |
| 1300            | 1331                    | 1200            | 1229                    | 1050       | 1100            | 1127                    | 1300       | 1000            | 1025                    | 1550       | 900             | 923                     | 1800       |
| 1400            | 1433                    | 1300            | 1331                    | 1250       | 1200            | 1229                    | 1500       | 1100            | 1127                    | 1750       | 1000            | 1025                    | 2000       |
| 1500            | 1535                    | 1400            | 1433                    | 1250       | 1300            | 1331                    | 1500       | 1200            | 1229                    | 1750       | 1100            | 1127                    | 2000       |
| 1600            | 1637                    | 1500            | 1535                    | 1250       | 1400            | 1433                    | 1500       | 1300            | 1331                    | 1750       | 1200            | 1229                    | 2000       |
| 1700            | 1739                    | 1600            | 1637                    | 1250       | 1500            | 1535                    | 1500       | 1400            | 1433                    | 1750       | 1300            | 1331                    | 2000       |
| 1800            | 1841                    | 1700            | 1739                    | 1250       | 1600            | 1637                    | 1500       | 1500            | 1535                    | 1750       | 1400            | 1433                    | 2000       |
| 1900            | 1943                    | 1800            | 1841                    | 1250       | 1700            | 1739                    | 1500       | 1600            | 1637                    | 1750       | 1500            | 1535                    | 2000       |

Sizes can be adapted to meet transport requirements. For project-related dimensions, please contact Amiblu.

Amiblu Holding GmbH | Pischeldorfer Str. 128 | 9020 Klagenfurt | Austria | +43 463 482424 | www.amiblu.com | info@amiblu.com

© Amiblu Holding GmbH. Figures may slightly vary due to manufacturing tolerances. Amiblu does not accept any liability for errors, omissions, and subsequent changes to technical data.

# Reducer PN 1

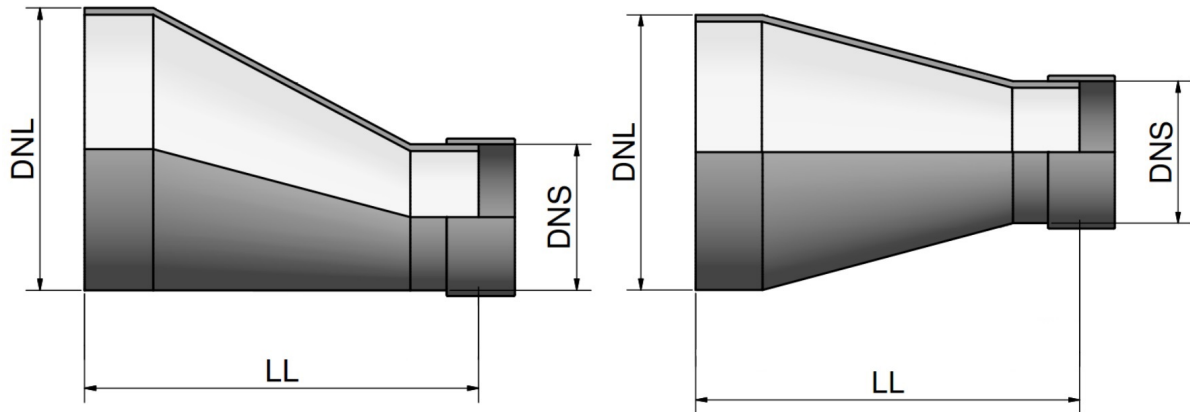

| DN <sub>L</sub> | d <sub>eL</sub><br>[mm] | DN <sub>S</sub> | d <sub>eS</sub><br>[mm] | LL<br>[mm] | DN <sub>S</sub> | d <sub>eS</sub><br>[mm] | LL<br>[mm] | DN <sub>S</sub> | d <sub>eS</sub><br>[mm] | LL<br>[mm] | DN <sub>S</sub> | d <sub>eS</sub><br>[mm] | LL<br>[mm] |
|-----------------|-------------------------|-----------------|-------------------------|------------|-----------------|-------------------------|------------|-----------------|-------------------------|------------|-----------------|-------------------------|------------|
| 2000            | 2045                    | 1900            | 1943                    | 1250       | 1800            | 1841                    | 1500       | 1700            | 1739                    | 1750       | 1600            | 1637                    | 2000       |
| 2100            | 2147                    | 2000            | 2045                    | 1250       | 1900            | 1943                    | 1500       | 1800            | 1841                    | 1750       | 1700            | 1739                    | 2000       |
| 2200            | 2249                    | 2100            | 2147                    | 1250       | 2000            | 2045                    | 1500       | 1900            | 1943                    | 1750       | 1800            | 1841                    | 2000       |
| 2300            | 2351                    | 2200            | 2249                    | 1250       | 2100            | 2147                    | 1500       | 2000            | 2045                    | 1750       | 1900            | 1943                    | 2000       |
| 2400            | 2453                    | 2300            | 2351                    | 1450       | 2200            | 2249                    | 1700       | 2100            | 2147                    | 1950       | 2000            | 2045                    | 2200       |
| 2500            | 2555                    | 2400            | 2453                    | 1450       | 2300            | 2351                    | 1700       | 2200            | 2249                    | 1950       | 2100            | 2147                    | 2200       |
| 2600            | 2657                    | 2500            | 2555                    | 1450       | 2400            | 2453                    | 1700       | 2300            | 2351                    | 1950       | 2200            | 2249                    | 2200       |
| 2700            | 2759                    | 2600            | 2657                    | 1450       | 2500            | 2555                    | 1700       | 2400            | 2453                    | 1950       | 2300            | 2351                    | 2200       |
| 2800            | 2861                    | 2700            | 2759                    | 1450       | 2600            | 2657                    | 1700       | 2500            | 2555                    | 1950       | 2400            | 2453                    | 2200       |
| 2900            | 2963                    | 2800            | 2861                    | 1450       | 2700            | 2759                    | 1700       | 2600            | 2657                    | 1950       | 2500            | 2555                    | 2200       |
| 3000            | 3065                    | 2900            | 2963                    | 1450       | 2800            | 2861                    | 1700       | 2700            | 2759                    | 1950       | 2600            | 2657                    | 2200       |
| 3100            | 3167                    | 3000            | 3065                    | 1450       | 2900            | 2963                    | 1700       | 2800            | 2861                    | 1950       | 2700            | 2759                    | 2200       |
| 3200            | 3269                    | 3100            | 3167                    | 1450       | 3000            | 3065                    | 1700       | 2900            | 2963                    | 1950       | 2800            | 2861                    | 2200       |

Sizes can be adapted to meet transport requirements. For project-related dimensions, please contact Amiblu.

Amiblu Holding GmbH | Pischeldorfer Str. 128 | 9020 Klagenfurt | Austria | +43 463 482424 | www.amiblu.com | info@amiblu.com

© Amiblu Holding GmbH. Figures may slightly vary due to manufacturing tolerances. Amiblu does not accept any liability for errors, omissions, and subsequent changes to technical data.

Publication: 05/2020

# y-Piece PN 1, 45°

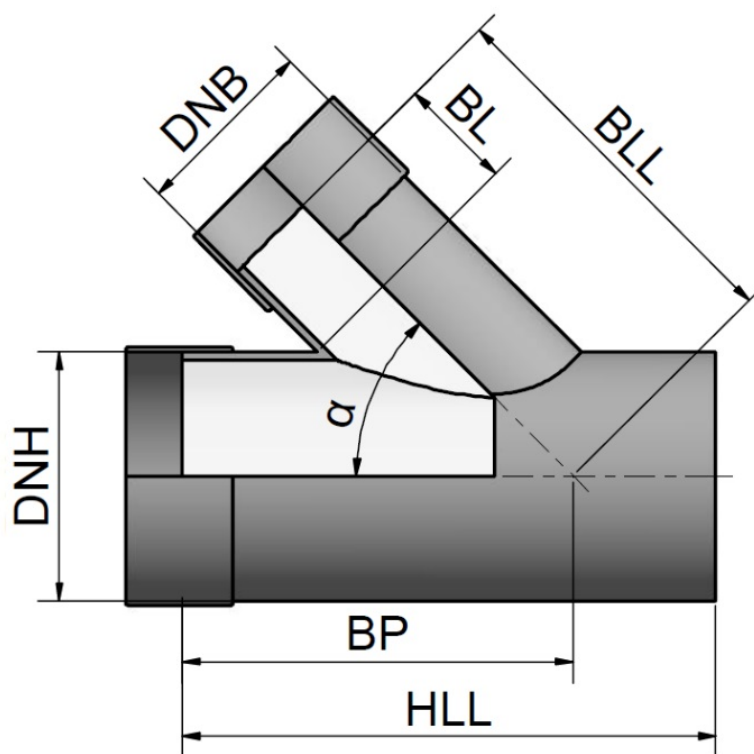

| DN <sub>H</sub> | d <sub>eH</sub><br>[mm] | DN <sub>B</sub> | d <sub>eB</sub><br>[mm] | HLL<br>[mm] | BL<br>[mm] | BLL<br>[mm] | BP<br>[mm] | α<br>[°] |
|-----------------|-------------------------|-----------------|-------------------------|-------------|------------|-------------|------------|----------|
| 200             | 220                     | 200             | 220                     | 850         | 284        | 550         | 550        | 45       |
| 250             | 272                     | 200             | 220                     | 850         | 298        | 600         | 600        | 45       |
|                 |                         | 250             | 272                     | 950         | 272        | 600         | 650        | 45       |
| 300             | 324                     | 200             | 220                     | 900         | 261        | 600         | 650        | 45       |
|                 |                         | 250             | 272                     | 1000        | 285        | 650         | 700        | 45       |
|                 |                         | 300             | 324                     | 1100        | 308        | 700         | 750        | 45       |
| 350             | 376                     | 200             | 220                     | 900         | 274        | 650         | 650        | 45       |
|                 |                         | 250             | 272                     | 1000        | 298        | 700         | 700        | 45       |
|                 |                         | 300             | 324                     | 1100        | 322        | 750         | 750        | 45       |
|                 |                         | 350             | 376                     | 1150        | 346        | 800         | 800        | 45       |
| 400             | 427                     | 200             | 220                     | 900         | 288        | 700         | 700        | 45       |
|                 |                         | 250             | 272                     | 1000        | 262        | 700         | 750        | 45       |
|                 |                         | 300             | 324                     | 1100        | 336        | 800         | 800        | 45       |
|                 |                         | 350             | 376                     | 1150        | 310        | 800         | 800        | 45       |
|                 |                         | 400             | 427                     | 1250        | 334        | 850         | 850        | 45       |

Table contains selected branch sizes. For our full portfolio, please visit [www.amiblu.com/amiblu-products](http://www.amiblu.com/amiblu-products).  
 Sizes can be adapted to meet transport requirements. For project-related dimensions, please contact Amiblu.

Amiblu Holding GmbH | Pischeldorfer Str. 128 | 9020 Klagenfurt | Austria | +43 463 482424 | [www.amiblu.com](http://www.amiblu.com) | [info@amiblu.com](mailto:info@amiblu.com)

© Amiblu Holding GmbH. Figures may slightly vary due to manufacturing tolerances. Amiblu does not accept any liability for errors, omissions, and subsequent changes to technical data.

# y-Piece PN 1, 45°

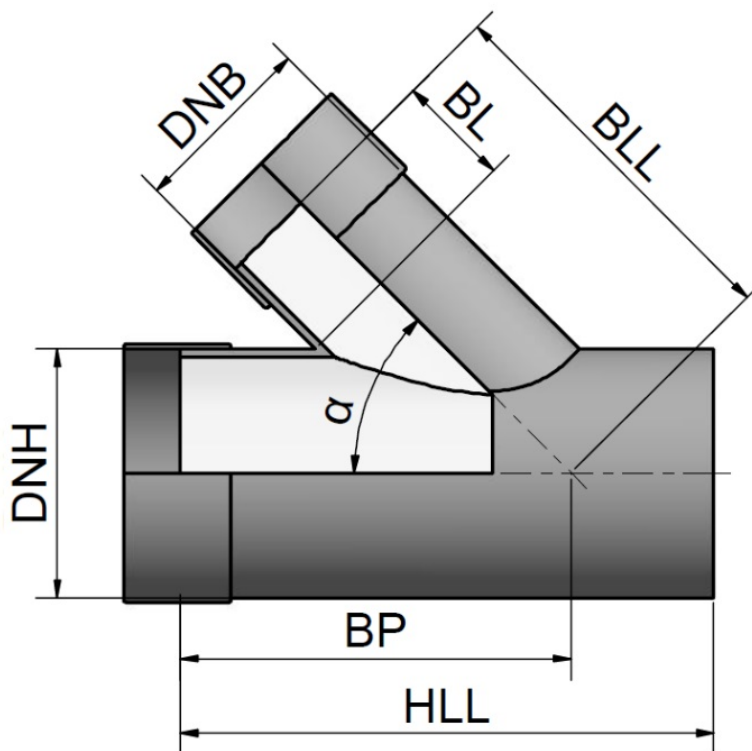

| DN <sub>H</sub> | d <sub>eH</sub><br>[mm] | DN <sub>B</sub> | d <sub>eB</sub><br>[mm] | HLL<br>[mm] | BL<br>[mm] | BLL<br>[mm] | BP<br>[mm] | α<br>[°] |
|-----------------|-------------------------|-----------------|-------------------------|-------------|------------|-------------|------------|----------|
| 450             | 478                     | 200             | 220                     | 900         | 302        | 750         | 700        | 45       |
|                 |                         | 300             | 324                     | 1100        | 350        | 850         | 800        | 45       |
|                 |                         | 350             | 376                     | 1150        | 324        | 850         | 850        | 45       |
|                 |                         | 400             | 427                     | 1250        | 348        | 900         | 900        | 45       |
|                 |                         | 450             | 478                     | 1300        | 323        | 900         | 900        | 45       |
| 500             | 530                     | 200             | 220                     | 900         | 265        | 750         | 750        | 45       |
|                 |                         | 300             | 324                     | 1100        | 313        | 850         | 850        | 45       |
|                 |                         | 400             | 427                     | 1250        | 312        | 900         | 900        | 45       |
|                 |                         | 450             | 478                     | 1300        | 336        | 950         | 950        | 45       |
|                 |                         | 500             | 530                     | 1400        | 310        | 950         | 1000       | 45       |
| 600             | 617                     | 200             | 220                     | 950         | 304        | 850         | 800        | 45       |
|                 |                         | 300             | 324                     | 1100        | 301        | 900         | 900        | 45       |
|                 |                         | 400             | 427                     | 1250        | 350        | 1000        | 950        | 45       |
|                 |                         | 450             | 478                     | 1350        | 325        | 1000        | 1000       | 45       |
|                 |                         | 600             | 617                     | 1550        | 355        | 1100        | 1100       | 45       |
| 700             | 719                     | 200             | 220                     | 950         | 282        | 900         | 850        | 45       |
|                 |                         | 350             | 376                     | 1200        | 303        | 1000        | 1000       | 45       |
|                 |                         | 450             | 478                     | 1350        | 303        | 1050        | 1050       | 45       |
|                 |                         | 500             | 530                     | 1400        | 327        | 1100        | 1100       | 45       |
|                 |                         | 700             | 719                     | 1700        | 332        | 1200        | 1250       | 45       |

Table contains selected branch sizes. For our full portfolio, please visit [www.amiblu.com/amiblu-products](http://www.amiblu.com/amiblu-products).  
 Sizes can be adapted to meet transport requirements. For project-related dimensions, please contact Amiblu.

Amiblu Holding GmbH | Pischeldorfer Str. 128 | 9020 Klagenfurt | Austria | +43 463 482424 | [www.amiblu.com](http://www.amiblu.com) | [info@amiblu.com](mailto:info@amiblu.com)

© Amiblu Holding GmbH. Figures may slightly vary due to manufacturing tolerances. Amiblu does not accept any liability for errors, omissions, and subsequent changes to technical data.



# y-Piece PN 1, 45°

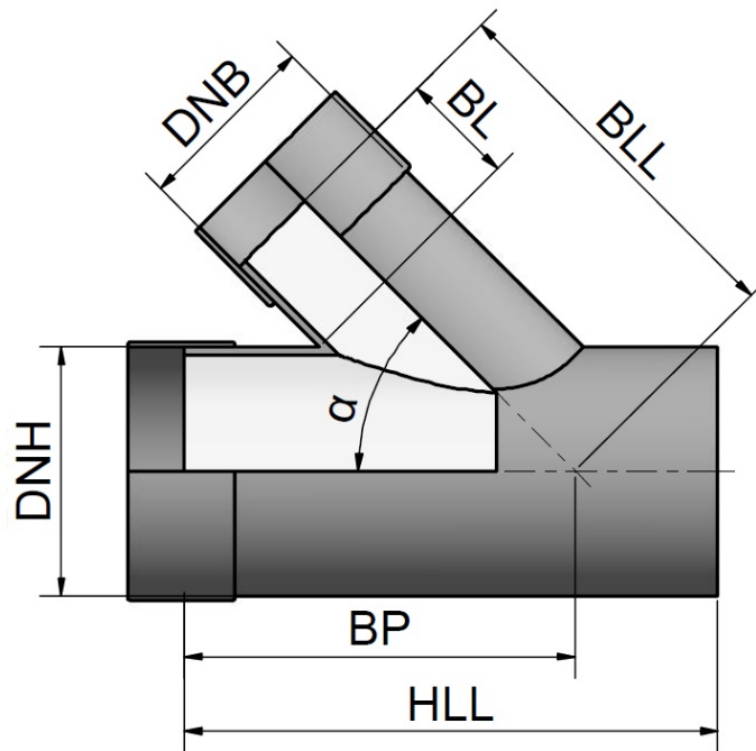

| DN <sub>H</sub> | d <sub>eH</sub><br>[mm] | DN <sub>B</sub> | d <sub>eB</sub><br>[mm] | HLL<br>[mm] | BL<br>[mm] | BLL<br>[mm] | BP<br>[mm] | α<br>[°] |
|-----------------|-------------------------|-----------------|-------------------------|-------------|------------|-------------|------------|----------|
| 800             | 821                     | 200             | 220                     | 950         | 260        | 950         | 900        | 45       |
|                 |                         | 350             | 376                     | 1200        | 331        | 1100        | 1050       | 45       |
|                 |                         | 450             | 478                     | 1350        | 330        | 1150        | 1100       | 45       |
|                 |                         | 600             | 617                     | 1550        | 361        | 1250        | 1200       | 45       |
|                 |                         | 800             | 821                     | 1850        | 359        | 1350        | 1350       | 45       |
| 900             | 923                     | 200             | 220                     | 950         | 287        | 1050        | 950        | 45       |
|                 |                         | 350             | 376                     | 1200        | 309        | 1150        | 1100       | 45       |
|                 |                         | 500             | 530                     | 1400        | 332        | 1250        | 1200       | 45       |
|                 |                         | 700             | 719                     | 1700        | 338        | 1350        | 1350       | 45       |
|                 |                         | 900             | 923                     | 2000        | 336        | 1450        | 1500       | 45       |
| 1000            | 1025                    | 200             | 220                     | 950         | 265        | 1100        | 1000       | 45       |
|                 |                         | 350             | 376                     | 1200        | 337        | 1250        | 1150       | 45       |
|                 |                         | 500             | 530                     | 1400        | 310        | 1300        | 1250       | 45       |
|                 |                         | 700             | 719                     | 1700        | 366        | 1450        | 1400       | 45       |
|                 |                         | 1000            | 1025                    | 2100        | 363        | 1600        | 1600       | 45       |
| 1100            | 1127                    | 200             | 220                     | 950         | 293        | 1200        | 1050       | 45       |
|                 |                         | 400             | 427                     | 1250        | 339        | 1350        | 1200       | 45       |
|                 |                         | 600             | 617                     | 1550        | 345        | 1450        | 1350       | 45       |
|                 |                         | 800             | 821                     | 1850        | 343        | 1550        | 1500       | 45       |
|                 |                         | 1100            | 1127                    | 2300        | 340        | 1700        | 1750       | 45       |

Table contains selected branch sizes. For our full portfolio, please visit [www.amiblu.com/amiblu-products](http://www.amiblu.com/amiblu-products).  
 Sizes can be adapted to meet transport requirements. For project-related dimensions, please contact Amiblu.

Amiblu Holding GmbH | Pischeldorfer Str. 128 | 9020 Klagenfurt | Austria | +43 463 482424 | [www.amiblu.com](http://www.amiblu.com) | [info@amiblu.com](mailto:info@amiblu.com)

© Amiblu Holding GmbH. Figures may slightly vary due to manufacturing tolerances. Amiblu does not accept any liability for errors, omissions, and subsequent changes to technical data.

# y-Piece PN 1, 45°

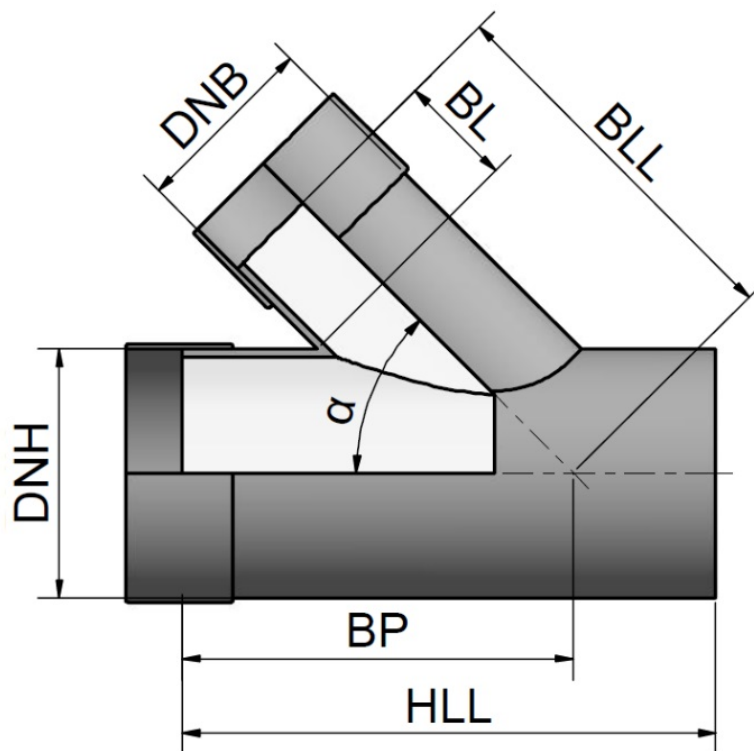

| DN <sub>H</sub> | d <sub>eH</sub><br>[mm] | DN <sub>B</sub> | d <sub>eB</sub><br>[mm] | HLL<br>[mm] | BL<br>[mm] | BLL<br>[mm] | BP<br>[mm] | α<br>[°] |
|-----------------|-------------------------|-----------------|-------------------------|-------------|------------|-------------|------------|----------|
| 1200            | 1229                    | 200             | 220                     | 950         | 271        | 1250        | 1100       | 45       |
|                 |                         | 400             | 427                     | 1250        | 317        | 1400        | 1250       | 45       |
|                 |                         | 600             | 617                     | 1550        | 323        | 1500        | 1400       | 45       |
|                 |                         | 900             | 923                     | 2000        | 370        | 1700        | 1650       | 45       |
|                 |                         | 1200            | 1229                    | 2450        | 367        | 1850        | 1850       | 45       |
| 1300            | 1331                    | 200             | 220                     | 950         | 299        | 1350        | 1150       | 45       |
|                 |                         | 400             | 427                     | 1250        | 345        | 1500        | 1300       | 45       |
|                 |                         | 700             | 719                     | 1700        | 349        | 1650        | 1550       | 45       |
|                 |                         | 1000            | 1025                    | 2100        | 346        | 1800        | 1750       | 45       |
|                 |                         | 1300            | 1331                    | 2600        | 343        | 1950        | 2000       | 45       |
| 1400            | 1433                    | 200             | 220                     | 950         | 277        | 1400        | 1200       | 45       |
|                 |                         | 400             | 427                     | 1250        | 323        | 1550        | 1350       | 45       |
|                 |                         | 700             | 719                     | 1700        | 327        | 1700        | 1600       | 45       |
|                 |                         | 1000            | 1025                    | 2100        | 324        | 1850        | 1800       | 45       |
|                 |                         | 1400            | 1433                    | 2750        | 370        | 2100        | 2100       | 45       |
| 1500            | 1535                    | 200             | 220                     | 1000        | 305        | 1500        | 1300       | 45       |
|                 |                         | 450             | 478                     | 1350        | 326        | 1650        | 1450       | 45       |
|                 |                         | 800             | 821                     | 1850        | 354        | 1850        | 1700       | 45       |
|                 |                         | 1100            | 1127                    | 2350        | 351        | 2000        | 1950       | 45       |
|                 |                         | 1500            | 1535                    | 2950        | 397        | 2250        | 2250       | 45       |

Table contains selected branch sizes. For our full portfolio, please visit [www.amiblu.com/amiblu-products](http://www.amiblu.com/amiblu-products).  
 Sizes can be adapted to meet transport requirements. For project-related dimensions, please contact Amiblu.

Amiblu Holding GmbH | Pischeldorfer Str. 128 | 9020 Klagenfurt | Austria | +43 463 482424 | [www.amiblu.com](http://www.amiblu.com) | [info@amiblu.com](mailto:info@amiblu.com)

© Amiblu Holding GmbH. Figures may slightly vary due to manufacturing tolerances. Amiblu does not accept any liability for errors, omissions, and subsequent changes to technical data.

# y-Piece PN 1, 45°

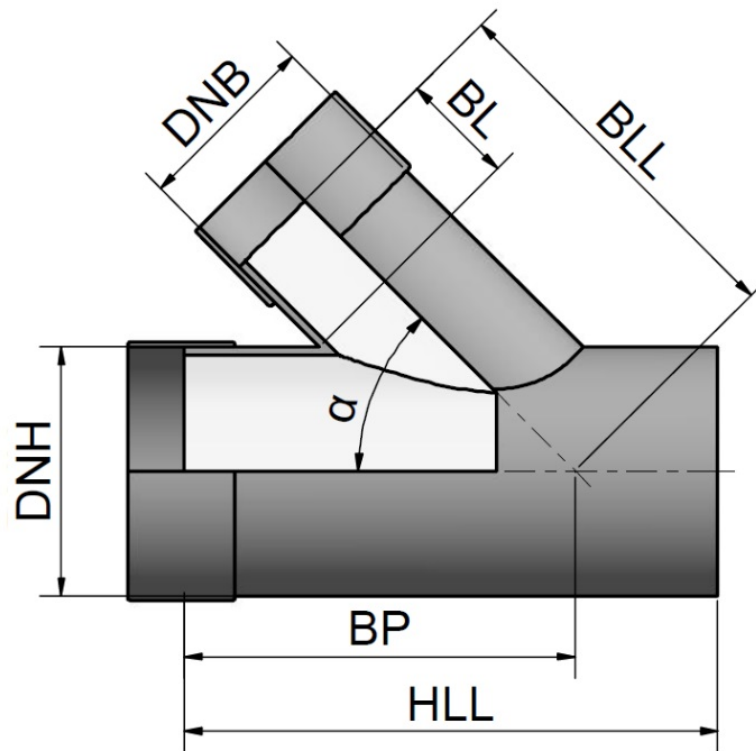

| DN <sub>H</sub> | d <sub>eH</sub><br>[mm] | DN <sub>B</sub> | d <sub>eB</sub><br>[mm] | HLL<br>[mm] | BL<br>[mm] | BLL<br>[mm] | BP<br>[mm] | α<br>[°] |
|-----------------|-------------------------|-----------------|-------------------------|-------------|------------|-------------|------------|----------|
| 1600            | 1637                    | 200             | 220                     | 1000        | 283        | 1550        | 1350       | 45       |
|                 |                         | 450             | 478                     | 1350        | 303        | 1700        | 1500       | 45       |
|                 |                         | 800             | 821                     | 1850        | 332        | 1900        | 1750       | 45       |
|                 |                         | 1200            | 1229                    | 2500        | 378        | 2150        | 2100       | 45       |
|                 |                         | 1600            | 1637                    | 3100        | 424        | 2400        | 2400       | 45       |
| 1700            | 1739                    | 200             | 220                     | 1000        | 260        | 1600        | 1400       | 45       |
|                 |                         | 450             | 478                     | 1350        | 331        | 1800        | 1550       | 45       |
|                 |                         | 900             | 923                     | 2000        | 359        | 2050        | 1900       | 45       |
|                 |                         | 1300            | 1331                    | 2650        | 355        | 2250        | 2200       | 45       |
|                 |                         | 1700            | 1739                    | 3250        | 401        | 2500        | 2500       | 45       |
| 1800            | 1841                    | 200             | 220                     | 1000        | 288        | 1700        | 1450       | 45       |
|                 |                         | 450             | 478                     | 1350        | 309        | 1850        | 1600       | 45       |
|                 |                         | 900             | 923                     | 2000        | 337        | 2100        | 1950       | 45       |
|                 |                         | 1300            | 1331                    | 2650        | 383        | 2350        | 2250       | 45       |
|                 |                         | 1800            | 1841                    | 3400        | 428        | 2650        | 2650       | 45       |
| 1900            | 1943                    | 200             | 220                     | 1000        | 266        | 1750        | 1500       | 45       |
|                 |                         | 500             | 530                     | 1450        | 311        | 1950        | 1700       | 45       |
|                 |                         | 1000            | 1025                    | 2150        | 364        | 2250        | 2050       | 45       |
|                 |                         | 1400            | 1433                    | 2800        | 360        | 2450        | 2400       | 45       |
|                 |                         | 1900            | 1943                    | 3550        | 405        | 2750        | 2750       | 45       |

Table contains selected branch sizes. For our full portfolio, please visit [www.amiblu.com/amiblu-products](http://www.amiblu.com/amiblu-products).  
 Sizes can be adapted to meet transport requirements. For project-related dimensions, please contact Amiblu.

Amiblu Holding GmbH | Pischeldorfer Str. 128 | 9020 Klagenfurt | Austria | +43 463 482424 | [www.amiblu.com](http://www.amiblu.com) | [info@amiblu.com](mailto:info@amiblu.com)

© Amiblu Holding GmbH. Figures may slightly vary due to manufacturing tolerances. Amiblu does not accept any liability for errors, omissions, and subsequent changes to technical data.

# y-Piece PN 1, 45°

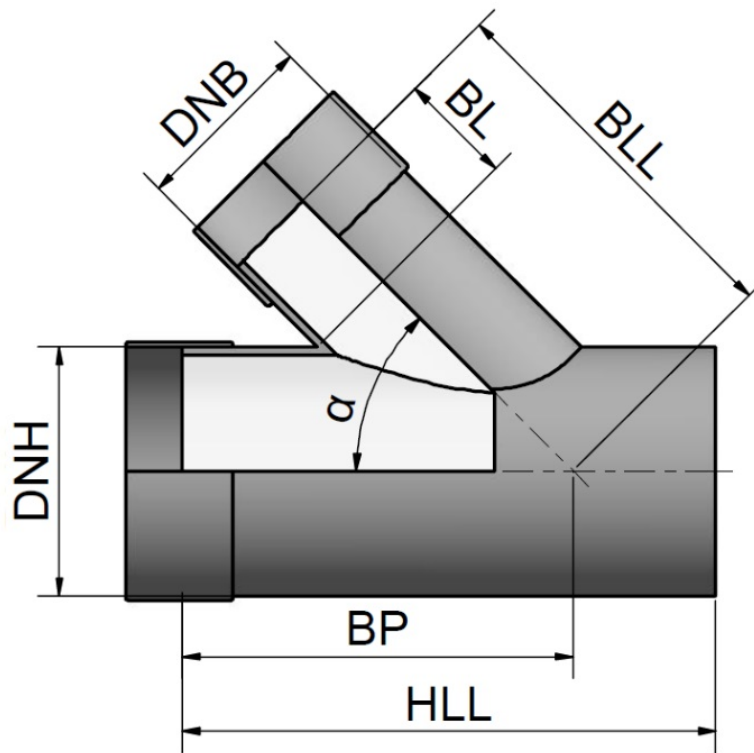

| DN <sub>H</sub> | d <sub>eH</sub><br>[mm] | DN <sub>B</sub> | d <sub>eB</sub><br>[mm] | HLL<br>[mm] | BL<br>[mm] | BLL<br>[mm] | BP<br>[mm] | α<br>[°] |
|-----------------|-------------------------|-----------------|-------------------------|-------------|------------|-------------|------------|----------|
| 2000            | 2045                    | 200             | 220                     | 1000        | 294        | 1850        | 1550       | 45       |
|                 |                         | 500             | 530                     | 1450        | 339        | 2050        | 1750       | 45       |
|                 |                         | 1000            | 1025                    | 2150        | 342        | 2300        | 2100       | 45       |
|                 |                         | 1500            | 1535                    | 2950        | 387        | 2600        | 2500       | 45       |
|                 |                         | 2000            | 2045                    | 3700        | 432        | 2900        | 2900       | 45       |
| 2100            | 2147                    | 200             | 220                     | 1000        | 272        | 1900        | 1600       | 45       |
|                 |                         | 500             | 530                     | 1450        | 317        | 2100        | 1800       | 45       |
|                 |                         | 1100            | 1127                    | 2350        | 368        | 2450        | 2250       | 45       |
|                 |                         | 1600            | 1637                    | 3100        | 413        | 2750        | 2650       | 45       |
|                 |                         | 2100            | 2147                    | 3850        | 408        | 3000        | 3000       | 45       |
| 2200            | 2249                    | 200             | 220                     | 1000        | 300        | 2000        | 1650       | 45       |
|                 |                         | 500             | 530                     | 1450        | 345        | 2200        | 1850       | 45       |
|                 |                         | 1100            | 1127                    | 2350        | 346        | 2500        | 2300       | 45       |
|                 |                         | 1600            | 1637                    | 3100        | 391        | 2800        | 2700       | 45       |
|                 |                         | 2200            | 2249                    | 4000        | 435        | 3150        | 3150       | 45       |
| 2300            | 2351                    | 200             | 220                     | 1000        | 278        | 2050        | 1700       | 45       |
|                 |                         | 600             | 617                     | 1550        | 329        | 2300        | 2000       | 45       |
|                 |                         | 1200            | 1229                    | 2500        | 373        | 2650        | 2450       | 45       |
|                 |                         | 1700            | 1739                    | 3250        | 418        | 2950        | 2850       | 45       |
|                 |                         | 2300            | 2351                    | 4150        | 412        | 3250        | 3300       | 45       |

Table contains selected branch sizes. For our full portfolio, please visit [www.amiblu.com/amiblu-products](http://www.amiblu.com/amiblu-products).  
 Sizes can be adapted to meet transport requirements. For project-related dimensions, please contact Amiblu.

Amiblu Holding GmbH | Pischeldorfer Str. 128 | 9020 Klagenfurt | Austria | +43 463 482424 | [www.amiblu.com](http://www.amiblu.com) | [info@amiblu.com](mailto:info@amiblu.com)

© Amiblu Holding GmbH. Figures may slightly vary due to manufacturing tolerances. Amiblu does not accept any liability for errors, omissions, and subsequent changes to technical data.

Publication: 05/2020

# y-Piece PN 1, 45°

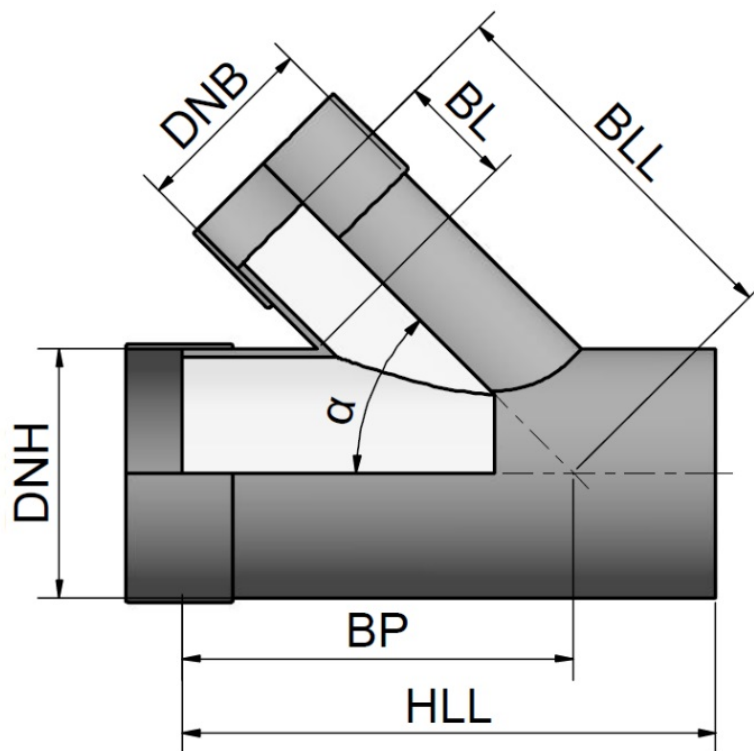

| DN <sub>H</sub> | d <sub>eH</sub><br>[mm] | DN <sub>B</sub> | d <sub>eB</sub><br>[mm] | HLL<br>[mm] | BL<br>[mm] | BLL<br>[mm] | BP<br>[mm] | α<br>[°] |
|-----------------|-------------------------|-----------------|-------------------------|-------------|------------|-------------|------------|----------|
| 2400            | 2453                    | 200             | 220                     | 1000        | 306        | 2150        | 1750       | 45       |
|                 |                         | 600             | 617                     | 1550        | 357        | 2400        | 2050       | 45       |
|                 |                         | 1200            | 1229                    | 2500        | 351        | 2700        | 2500       | 45       |
|                 |                         | 1800            | 1841                    | 3400        | 395        | 3050        | 2950       | 45       |
|                 |                         | 2400            | 2453                    | 4350        | 439        | 3400        | 3450       | 45       |
| 2500            | 2555                    | 200             | 220                     | 1000        | 283        | 2200        | 1800       | 45       |
|                 |                         | 600             | 617                     | 1550        | 335        | 2450        | 2100       | 45       |
|                 |                         | 1300            | 1331                    | 2650        | 378        | 2850        | 2650       | 45       |
|                 |                         | 1900            | 1943                    | 3550        | 422        | 3200        | 3100       | 45       |
|                 |                         | 2500            | 2555                    | 4500        | 466        | 3550        | 3550       | 45       |
| 2600            | 2657                    | 200             | 220                     | 1000        | 261        | 2250        | 1850       | 45       |
|                 |                         | 600             | 617                     | 1600        | 363        | 2550        | 2150       | 45       |
|                 |                         | 1300            | 1331                    | 2650        | 356        | 2900        | 2700       | 45       |
|                 |                         | 1900            | 1943                    | 3600        | 400        | 3250        | 3150       | 45       |
|                 |                         | 2600            | 2657                    | 4650        | 443        | 3650        | 3700       | 45       |
| 2700            | 2759                    | 200             | 220                     | 1000        | 289        | 2350        | 1900       | 45       |
|                 |                         | 700             | 719                     | 1750        | 340        | 2650        | 2300       | 45       |
|                 |                         | 1400            | 1433                    | 2800        | 383        | 3050        | 2800       | 45       |
|                 |                         | 2000            | 2045                    | 3750        | 427        | 3400        | 3300       | 45       |
|                 |                         | 2700            | 2759                    | 4800        | 470        | 3800        | 3800       | 45       |

Table contains selected branch sizes. For our full portfolio, please visit [www.amiblu.com/amiblu-products](http://www.amiblu.com/amiblu-products).  
 Sizes can be adapted to meet transport requirements. For project-related dimensions, please contact Amiblu.

Amiblu Holding GmbH | Pischeldorfer Str. 128 | 9020 Klagenfurt | Austria | +43 463 482424 | [www.amiblu.com](http://www.amiblu.com) | [info@amiblu.com](mailto:info@amiblu.com)

© Amiblu Holding GmbH. Figures may slightly vary due to manufacturing tolerances. Amiblu does not accept any liability for errors, omissions, and subsequent changes to technical data.

# y-Piece PN 1, 45°

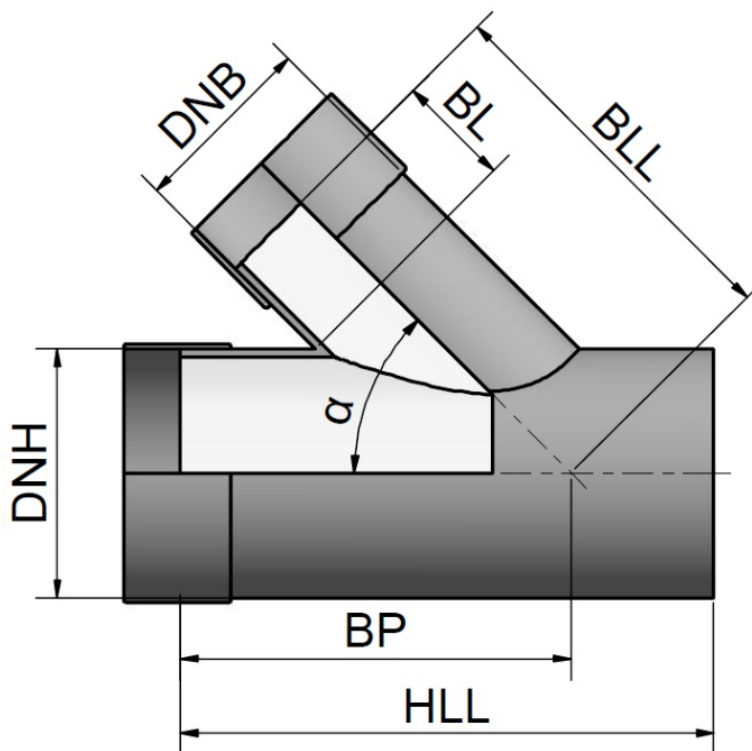

| DN <sub>H</sub> | d <sub>eH</sub><br>[mm] | DN <sub>B</sub> | d <sub>eB</sub><br>[mm] | HLL<br>[mm] | BL<br>[mm] | BLL<br>[mm] | BP<br>[mm] | α<br>[°] |
|-----------------|-------------------------|-----------------|-------------------------|-------------|------------|-------------|------------|----------|
| 2800            | 2861                    | 200             | 220                     | 1000        | 267        | 2400        | 1950       | 45       |
|                 |                         | 700             | 719                     | 1750        | 368        | 2750        | 2350       | 45       |
|                 |                         | 1400            | 1433                    | 2800        | 361        | 3100        | 2850       | 45       |
|                 |                         | 2100            | 2147                    | 3900        | 404        | 3500        | 3400       | 45       |
|                 |                         | 2800            | 2861                    | 4950        | 497        | 3950        | 3950       | 45       |
| 2900            | 2963                    | 200             | 220                     | 1000        | 295        | 2500        | 2000       | 45       |
|                 |                         | 700             | 719                     | 1750        | 345        | 2800        | 2400       | 45       |
|                 |                         | 1500            | 1535                    | 3000        | 387        | 3250        | 3000       | 45       |
|                 |                         | 2200            | 2249                    | 4050        | 430        | 3650        | 3550       | 45       |
|                 |                         | 2900            | 2963                    | 5100        | 473        | 4050        | 4050       | 45       |
| 3000            | 3065                    | 200             | 220                     | 1000        | 273        | 2550        | 2050       | 45       |
|                 |                         | 700             | 719                     | 1750        | 323        | 2850        | 2450       | 45       |
|                 |                         | 1500            | 1535                    | 3000        | 415        | 3350        | 3050       | 45       |
|                 |                         | 2200            | 2249                    | 4050        | 408        | 3700        | 3600       | 45       |
|                 |                         | 3000            | 3065                    | 5250        | 500        | 4200        | 4200       | 45       |
| 3100            | 3167                    | 200             | 220                     | 1000        | 301        | 2650        | 2100       | 45       |
|                 |                         | 800             | 821                     | 1900        | 350        | 3000        | 2550       | 45       |
|                 |                         | 1600            | 1637                    | 3150        | 392        | 3450        | 3200       | 45       |
|                 |                         | 2300            | 2351                    | 4200        | 435        | 3850        | 3700       | 45       |
|                 |                         | 3100            | 3167                    | 5450        | 477        | 4300        | 4350       | 45       |

Table contains selected branch sizes. For our full portfolio, please visit [www.amiblu.com/amiblu-products](http://www.amiblu.com/amiblu-products).  
 Sizes can be adapted to meet transport requirements. For project-related dimensions, please contact Amiblu.

Amiblu Holding GmbH | Pischeldorfer Str. 128 | 9020 Klagenfurt | Austria | +43 463 482424 | [www.amiblu.com](http://www.amiblu.com) | [info@amiblu.com](mailto:info@amiblu.com)

© Amiblu Holding GmbH. Figures may slightly vary due to manufacturing tolerances. Amiblu does not accept any liability for errors, omissions, and subsequent changes to technical data.

Publication: 05/2020

# y-Piece PN 1, 45°

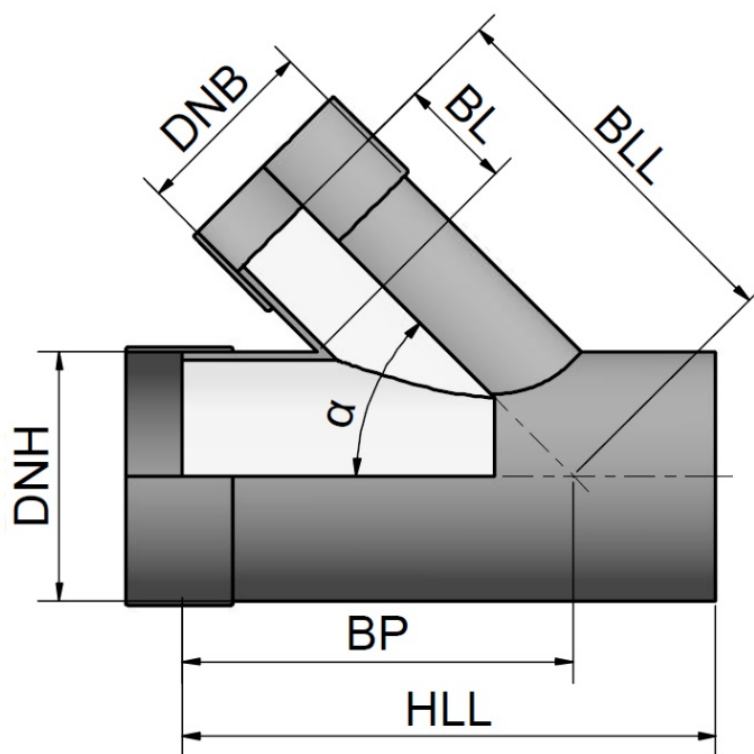

| DN <sub>H</sub> | d <sub>eH</sub><br>[mm] | DN <sub>B</sub> | d <sub>eB</sub><br>[mm] | HLL<br>[mm] | BL<br>[mm] | BLL<br>[mm] | BP<br>[mm] | α<br>[°] |
|-----------------|-------------------------|-----------------|-------------------------|-------------|------------|-------------|------------|----------|
| 3200            | 3269                    | 200             | 220                     | 1000        | 279        | 2700        | 2150       | 45       |
|                 |                         | 800             | 821                     | 1900        | 328        | 3050        | 2600       | 45       |
|                 |                         | 1600            | 1637                    | 3150        | 420        | 3550        | 3250       | 45       |
|                 |                         | 2400            | 2453                    | 4350        | 462        | 4000        | 3850       | 45       |
|                 |                         | 3200            | 3269                    | 5600        | 504        | 4450        | 4450       | 45       |

Table contains selected branch sizes. For our full portfolio, please visit [www.amiblu.com/amiblu-products](http://www.amiblu.com/amiblu-products).  
 Sizes can be adapted to meet transport requirements. For project-related dimensions, please contact Amiblu.

Amiblu Holding GmbH | Pischeldorfer Str. 128 | 9020 Klagenfurt | Austria | +43 463 482424 | [www.amiblu.com](http://www.amiblu.com) | [info@amiblu.com](mailto:info@amiblu.com)

© Amiblu Holding GmbH. Figures may slightly vary due to manufacturing tolerances. Amiblu does not accept any liability for errors, omissions, and subsequent changes to technical data.

Publication: 05/2020

# y-Piece PN 1, 60°

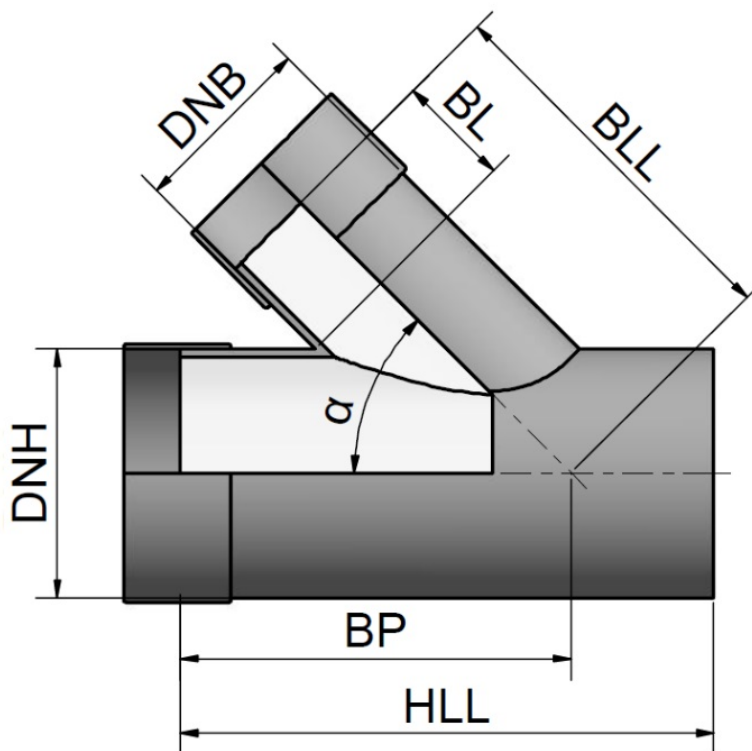

| DN <sub>H</sub> | d <sub>eH</sub><br>[mm] | DN <sub>B</sub> | d <sub>eB</sub><br>[mm] | HLL<br>[mm] | BL<br>[mm] | BLL<br>[mm] | BP<br>[mm] | α<br>[°] |
|-----------------|-------------------------|-----------------|-------------------------|-------------|------------|-------------|------------|----------|
| 200             | 220                     | 200             | 220                     | 800         | 260        | 450         | 500        | 60       |
| 250             | 272                     | 200             | 220                     | 800         | 280        | 500         | 500        | 60       |
|                 |                         | 250             | 272                     | 850         | 265        | 500         | 550        | 60       |
| 300             | 324                     | 200             | 220                     | 850         | 299        | 550         | 550        | 60       |
|                 |                         | 250             | 272                     | 950         | 284        | 550         | 600        | 60       |
|                 |                         | 300             | 324                     | 1000        | 319        | 600         | 600        | 60       |
| 350             | 376                     | 200             | 220                     | 850         | 269        | 550         | 550        | 60       |
|                 |                         | 250             | 272                     | 950         | 304        | 600         | 600        | 60       |
|                 |                         | 300             | 324                     | 1000        | 339        | 650         | 650        | 60       |
|                 |                         | 350             | 376                     | 1050        | 324        | 650         | 650        | 60       |
| 400             | 427                     | 200             | 220                     | 850         | 290        | 600         | 550        | 60       |
|                 |                         | 250             | 272                     | 950         | 275        | 600         | 600        | 60       |
|                 |                         | 300             | 324                     | 1000        | 310        | 650         | 650        | 60       |
|                 |                         | 350             | 376                     | 1050        | 345        | 700         | 650        | 60       |
|                 |                         | 400             | 427                     | 1100        | 330        | 700         | 700        | 60       |

Table contains selected branch sizes. For our full portfolio, please visit [www.amiblu.com/amiblu-products](http://www.amiblu.com/amiblu-products).  
 Sizes can be adapted to meet transport requirements. For project-related dimensions, please contact Amiblu.

Amiblu Holding GmbH | Pischeldorfer Str. 128 | 9020 Klagenfurt | Austria | +43 463 482424 | [www.amiblu.com](http://www.amiblu.com) | [info@amiblu.com](mailto:info@amiblu.com)

© Amiblu Holding GmbH. Figures may slightly vary due to manufacturing tolerances. Amiblu does not accept any liability for errors, omissions, and subsequent changes to technical data.

Publication: 05/2020



# y-Piece PN 1, 60°

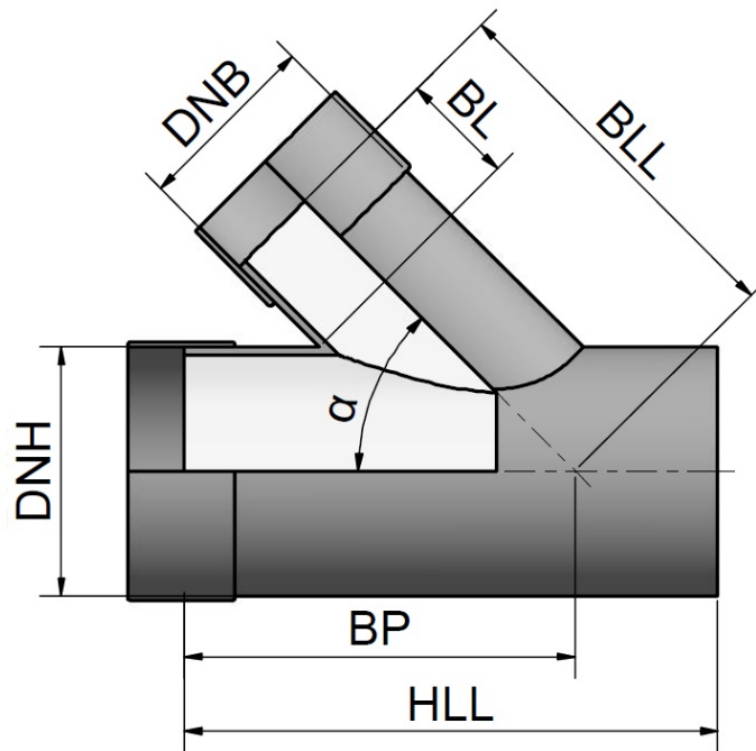

| DN <sub>H</sub> | d <sub>eH</sub><br>[mm] | DN <sub>B</sub> | d <sub>eB</sub><br>[mm] | HLL<br>[mm] | BL<br>[mm] | BLL<br>[mm] | BP<br>[mm] | α<br>[°] |
|-----------------|-------------------------|-----------------|-------------------------|-------------|------------|-------------|------------|----------|
| 450             | 478                     | 200             | 220                     | 850         | 260        | 600         | 600        | 60       |
|                 |                         | 300             | 324                     | 1000        | 330        | 700         | 650        | 60       |
|                 |                         | 350             | 376                     | 1050        | 315        | 700         | 700        | 60       |
|                 |                         | 400             | 427                     | 1100        | 351        | 750         | 700        | 60       |
|                 |                         | 450             | 478                     | 1200        | 336        | 750         | 750        | 60       |
| 500             | 530                     | 200             | 220                     | 850         | 280        | 650         | 600        | 60       |
|                 |                         | 300             | 324                     | 1000        | 350        | 750         | 700        | 60       |
|                 |                         | 400             | 427                     | 1100        | 321        | 750         | 750        | 60       |
|                 |                         | 450             | 478                     | 1200        | 306        | 750         | 800        | 60       |
|                 |                         | 500             | 530                     | 1250        | 341        | 800         | 800        | 60       |
| 600             | 617                     | 200             | 220                     | 900         | 280        | 700         | 650        | 60       |
|                 |                         | 300             | 324                     | 1050        | 350        | 800         | 750        | 60       |
|                 |                         | 400             | 427                     | 1150        | 320        | 800         | 800        | 60       |
|                 |                         | 450             | 478                     | 1200        | 306        | 800         | 800        | 60       |
|                 |                         | 600             | 617                     | 1350        | 316        | 850         | 900        | 60       |
| 700             | 719                     | 200             | 220                     | 900         | 271        | 750         | 700        | 60       |
|                 |                         | 350             | 376                     | 1100        | 326        | 850         | 800        | 60       |
|                 |                         | 450             | 478                     | 1200        | 347        | 900         | 850        | 60       |
|                 |                         | 500             | 530                     | 1250        | 332        | 900         | 850        | 60       |
|                 |                         | 700             | 719                     | 1500        | 327        | 950         | 1000       | 60       |

Table contains selected branch sizes. For our full portfolio, please visit [www.amiblu.com/amiblu-products](http://www.amiblu.com/amiblu-products).  
 Sizes can be adapted to meet transport requirements. For project-related dimensions, please contact Amiblu.

Amiblu Holding GmbH | Pischeldorfer Str. 128 | 9020 Klagenfurt | Austria | +43 463 482424 | [www.amiblu.com](http://www.amiblu.com) | [info@amiblu.com](mailto:info@amiblu.com)

© Amiblu Holding GmbH. Figures may slightly vary due to manufacturing tolerances. Amiblu does not accept any liability for errors, omissions, and subsequent changes to technical data.

# y-Piece PN 1, 60°

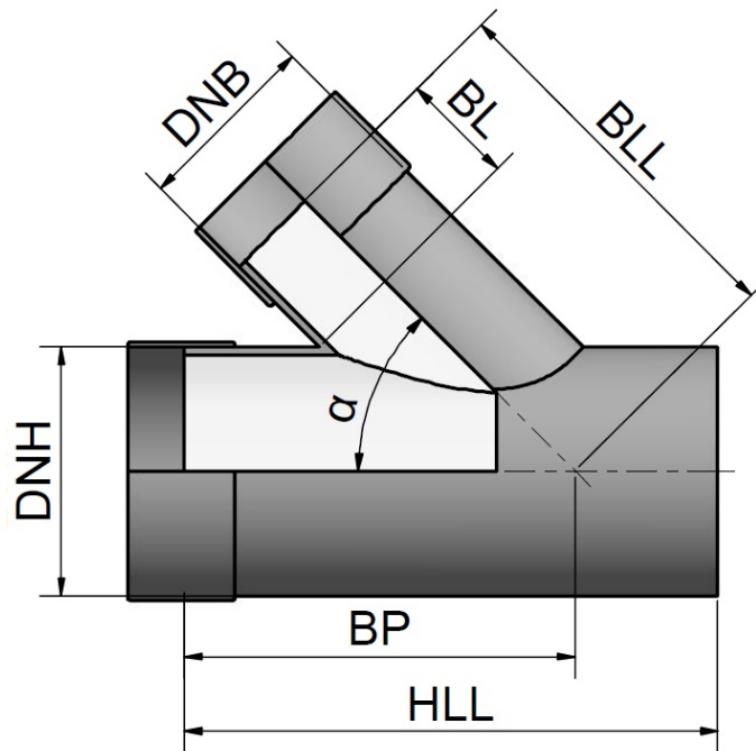

| DN <sub>H</sub> | d <sub>eH</sub><br>[mm] | DN <sub>B</sub> | d <sub>eB</sub><br>[mm] | HLL<br>[mm] | BL<br>[mm] | BLL<br>[mm] | BP<br>[mm] | α<br>[°] |
|-----------------|-------------------------|-----------------|-------------------------|-------------|------------|-------------|------------|----------|
| 800             | 821                     | 200             | 220                     | 900         | 263        | 800         | 700        | 60       |
|                 |                         | 350             | 376                     | 1100        | 317        | 900         | 800        | 60       |
|                 |                         | 450             | 478                     | 1200        | 338        | 950         | 850        | 60       |
|                 |                         | 600             | 617                     | 1350        | 348        | 1000        | 950        | 60       |
|                 |                         | 800             | 821                     | 1600        | 339        | 1050        | 1050       | 60       |
| 900             | 923                     | 200             | 220                     | 900         | 304        | 900         | 750        | 60       |
|                 |                         | 350             | 376                     | 1100        | 308        | 950         | 850        | 60       |
|                 |                         | 500             | 530                     | 1250        | 314        | 1000        | 900        | 60       |
|                 |                         | 700             | 719                     | 1500        | 360        | 1100        | 1050       | 60       |
|                 |                         | 900             | 923                     | 1750        | 351        | 1150        | 1150       | 60       |
| 1000            | 1025                    | 200             | 220                     | 900         | 295        | 950         | 750        | 60       |
|                 |                         | 350             | 376                     | 1100        | 350        | 1050        | 850        | 60       |
|                 |                         | 500             | 530                     | 1250        | 305        | 1050        | 950        | 60       |
|                 |                         | 700             | 719                     | 1500        | 351        | 1150        | 1050       | 60       |
|                 |                         | 1000            | 1025                    | 1850        | 362        | 1250        | 1250       | 60       |
| 1100            | 1127                    | 200             | 220                     | 900         | 286        | 1000        | 800        | 60       |
|                 |                         | 400             | 427                     | 1150        | 326        | 1100        | 950        | 60       |
|                 |                         | 600             | 617                     | 1350        | 321        | 1150        | 1050       | 60       |
|                 |                         | 800             | 821                     | 1600        | 362        | 1250        | 1150       | 60       |
|                 |                         | 1100            | 1127                    | 2000        | 374        | 1350        | 1350       | 60       |

Table contains selected branch sizes. For our full portfolio, please visit [www.amiblu.com/amiblu-products](http://www.amiblu.com/amiblu-products).  
 Sizes can be adapted to meet transport requirements. For project-related dimensions, please contact Amiblu.

Amiblu Holding GmbH | Pischeldorfer Str. 128 | 9020 Klagenfurt | Austria | +43 463 482424 | [www.amiblu.com](http://www.amiblu.com) | [info@amiblu.com](mailto:info@amiblu.com)

© Amiblu Holding GmbH. Figures may slightly vary due to manufacturing tolerances. Amiblu does not accept any liability for errors, omissions, and subsequent changes to technical data.

# y-Piece PN 1, 60°

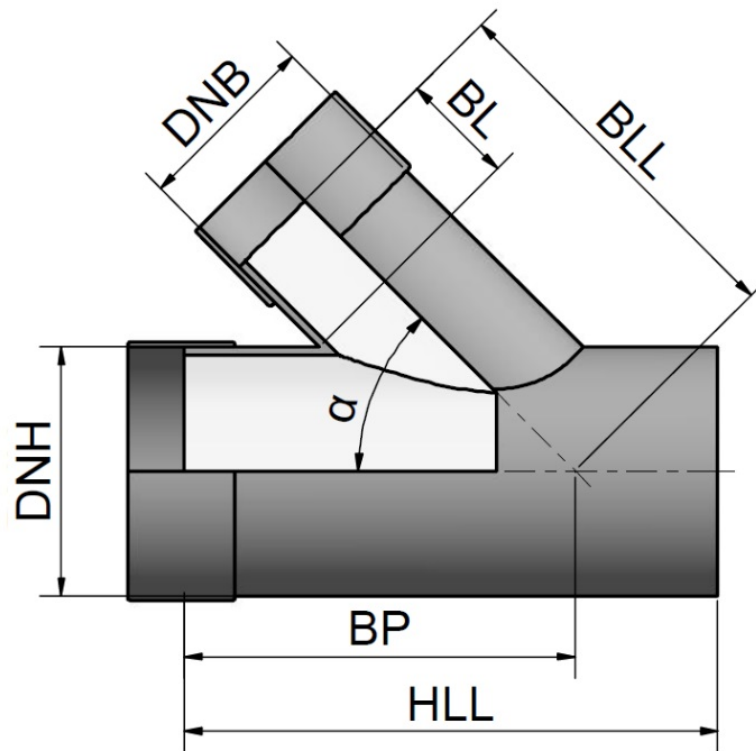

| DN <sub>H</sub> | d <sub>eH</sub><br>[mm] | DN <sub>B</sub> | d <sub>eB</sub><br>[mm] | HLL<br>[mm] | BL<br>[mm] | BLL<br>[mm] | BP<br>[mm] | α<br>[°] |
|-----------------|-------------------------|-----------------|-------------------------|-------------|------------|-------------|------------|----------|
| 1200            | 1229                    | 200             | 220                     | 900         | 277        | 1050        | 850        | 60       |
|                 |                         | 400             | 427                     | 1150        | 317        | 1150        | 950        | 60       |
|                 |                         | 600             | 617                     | 1350        | 362        | 1250        | 1050       | 60       |
|                 |                         | 900             | 923                     | 1750        | 324        | 1300        | 1250       | 60       |
|                 |                         | 1200            | 1229                    | 2100        | 386        | 1450        | 1450       | 60       |
| 1300            | 1331                    | 200             | 220                     | 900         | 268        | 1100        | 850        | 60       |
|                 |                         | 400             | 427                     | 1150        | 308        | 1200        | 1000       | 60       |
|                 |                         | 700             | 719                     | 1500        | 324        | 1300        | 1150       | 60       |
|                 |                         | 1000            | 1025                    | 1850        | 336        | 1400        | 1350       | 60       |
|                 |                         | 1300            | 1331                    | 2250        | 347        | 1500        | 1550       | 60       |
| 1400            | 1433                    | 200             | 220                     | 900         | 259        | 1150        | 900        | 60       |
|                 |                         | 400             | 427                     | 1150        | 349        | 1300        | 1000       | 60       |
|                 |                         | 700             | 719                     | 1500        | 365        | 1400        | 1200       | 60       |
|                 |                         | 1000            | 1025                    | 1850        | 327        | 1450        | 1350       | 60       |
|                 |                         | 1400            | 1433                    | 2400        | 359        | 1600        | 1650       | 60       |
| 1500            | 1535                    | 200             | 220                     | 950         | 300        | 1250        | 950        | 60       |
|                 |                         | 450             | 478                     | 1250        | 326        | 1350        | 1100       | 60       |
|                 |                         | 800             | 821                     | 1650        | 327        | 1450        | 1300       | 60       |
|                 |                         | 1100            | 1127                    | 2050        | 389        | 1600        | 1500       | 60       |
|                 |                         | 1500            | 1535                    | 2550        | 421        | 1750        | 1750       | 60       |

Table contains selected branch sizes. For our full portfolio, please visit [www.amiblu.com/amiblu-products](http://www.amiblu.com/amiblu-products).  
 Sizes can be adapted to meet transport requirements. For project-related dimensions, please contact Amiblu.

Amiblu Holding GmbH | Pischeldorfer Str. 128 | 9020 Klagenfurt | Austria | +43 463 482424 | [www.amiblu.com](http://www.amiblu.com) | [info@amiblu.com](mailto:info@amiblu.com)

© Amiblu Holding GmbH. Figures may slightly vary due to manufacturing tolerances. Amiblu does not accept any liability for errors, omissions, and subsequent changes to technical data.

# y-Piece PN 1, 60°

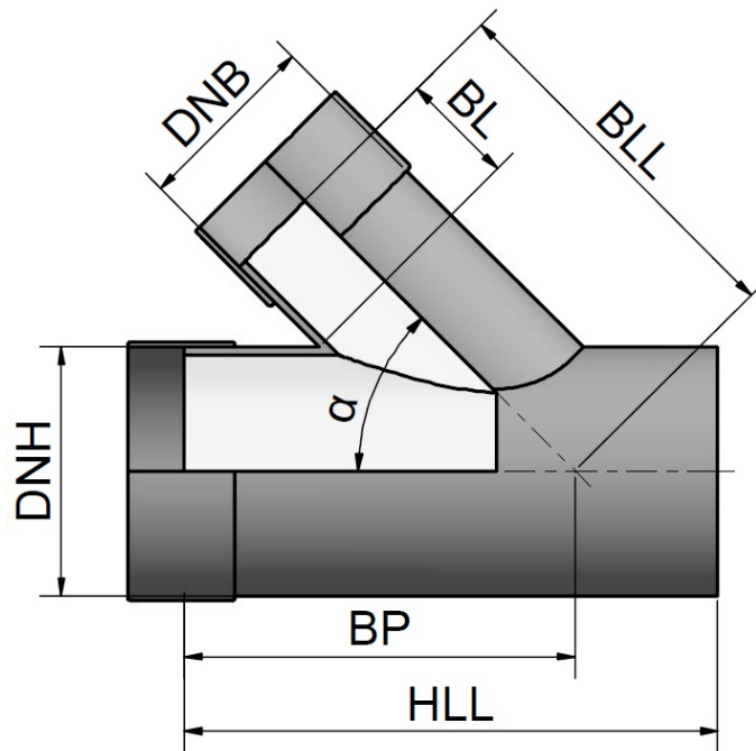

| DN <sub>H</sub> | d <sub>eH</sub><br>[mm] | DN <sub>B</sub> | d <sub>eB</sub><br>[mm] | HLL<br>[mm] | BL<br>[mm] | BLL<br>[mm] | BP<br>[mm] | α<br>[°] |
|-----------------|-------------------------|-----------------|-------------------------|-------------|------------|-------------|------------|----------|
| 1600            | 1637                    | 200             | 220                     | 950         | 291        | 1300        | 950        | 60       |
|                 |                         | 450             | 478                     | 1250        | 317        | 1400        | 1100       | 60       |
|                 |                         | 800             | 821                     | 1650        | 368        | 1550        | 1300       | 60       |
|                 |                         | 1200            | 1229                    | 2150        | 350        | 1650        | 1550       | 60       |
|                 |                         | 1600            | 1637                    | 2650        | 382        | 1800        | 1800       | 60       |
| 1700            | 1739                    | 200             | 220                     | 950         | 283        | 1350        | 1000       | 60       |
|                 |                         | 450             | 478                     | 1250        | 308        | 1450        | 1150       | 60       |
|                 |                         | 900             | 923                     | 1800        | 330        | 1600        | 1450       | 60       |
|                 |                         | 1300            | 1331                    | 2300        | 362        | 1750        | 1700       | 60       |
|                 |                         | 1700            | 1739                    | 2800        | 394        | 1900        | 1950       | 60       |
| 1800            | 1841                    | 200             | 220                     | 950         | 274        | 1400        | 1050       | 60       |
|                 |                         | 450             | 478                     | 1250        | 349        | 1550        | 1200       | 60       |
|                 |                         | 900             | 923                     | 1800        | 371        | 1700        | 1450       | 60       |
|                 |                         | 1300            | 1331                    | 2300        | 353        | 1800        | 1700       | 60       |
|                 |                         | 1800            | 1841                    | 2900        | 406        | 2000        | 2000       | 60       |
| 1900            | 1943                    | 200             | 220                     | 950         | 265        | 1450        | 1050       | 60       |
|                 |                         | 500             | 530                     | 1300        | 325        | 1600        | 1250       | 60       |
|                 |                         | 1000            | 1025                    | 1900        | 332        | 1750        | 1550       | 60       |
|                 |                         | 1400            | 1433                    | 2400        | 365        | 1900        | 1800       | 60       |
|                 |                         | 1900            | 1943                    | 3050        | 417        | 2100        | 2100       | 60       |

Table contains selected branch sizes. For our full portfolio, please visit [www.amiblu.com/amiblu-products](http://www.amiblu.com/amiblu-products).  
 Sizes can be adapted to meet transport requirements. For project-related dimensions, please contact Amiblu.

Amiblu Holding GmbH | Pischeldorfer Str. 128 | 9020 Klagenfurt | Austria | +43 463 482424 | [www.amiblu.com](http://www.amiblu.com) | [info@amiblu.com](mailto:info@amiblu.com)

© Amiblu Holding GmbH. Figures may slightly vary due to manufacturing tolerances. Amiblu does not accept any liability for errors, omissions, and subsequent changes to technical data.

# y-Piece PN 1, 60°

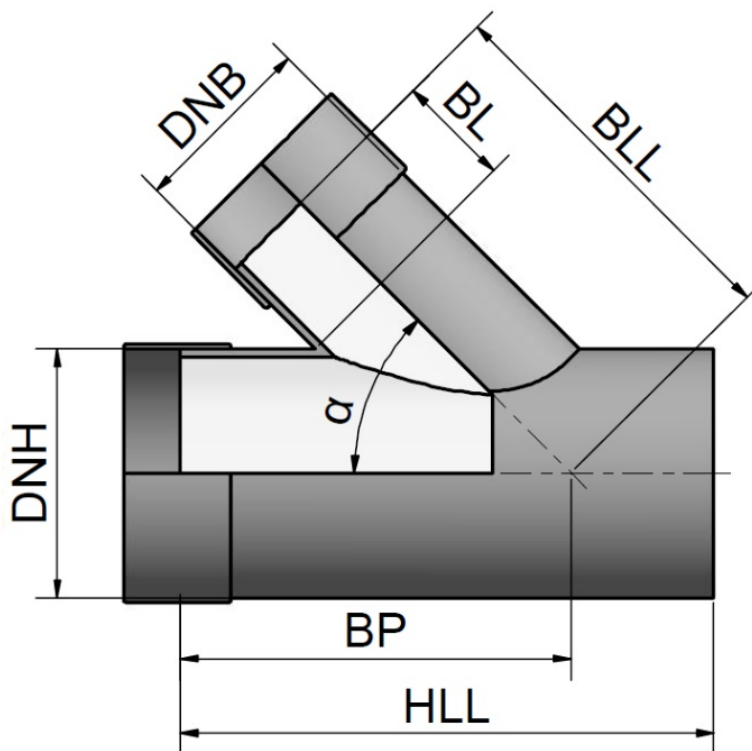

| DN <sub>H</sub> | d <sub>eH</sub><br>[mm] | DN <sub>B</sub> | d <sub>eB</sub><br>[mm] | HLL<br>[mm] | BL<br>[mm] | BLL<br>[mm] | BP<br>[mm] | α<br>[°] |
|-----------------|-------------------------|-----------------|-------------------------|-------------|------------|-------------|------------|----------|
| 2000            | 2045                    | 200             | 220                     | 950         | 306        | 1550        | 1100       | 60       |
|                 |                         | 500             | 530                     | 1300        | 316        | 1650        | 1250       | 60       |
|                 |                         | 1000            | 1025                    | 1900        | 323        | 1800        | 1550       | 60       |
|                 |                         | 1500            | 1535                    | 2550        | 426        | 2050        | 1900       | 60       |
|                 |                         | 2000            | 2045                    | 3150        | 429        | 2200        | 2200       | 60       |
| 2100            | 2147                    | 200             | 220                     | 950         | 297        | 1600        | 1100       | 60       |
|                 |                         | 500             | 530                     | 1300        | 307        | 1700        | 1300       | 60       |
|                 |                         | 1100            | 1127                    | 2050        | 385        | 1950        | 1650       | 60       |
|                 |                         | 1600            | 1637                    | 2650        | 388        | 2100        | 1950       | 60       |
|                 |                         | 2100            | 2147                    | 3300        | 441        | 2300        | 2300       | 60       |
| 2200            | 2249                    | 200             | 220                     | 950         | 288        | 1650        | 1150       | 60       |
|                 |                         | 500             | 530                     | 1300        | 349        | 1800        | 1300       | 60       |
|                 |                         | 1100            | 1127                    | 2050        | 376        | 2000        | 1700       | 60       |
|                 |                         | 1600            | 1637                    | 2650        | 379        | 2150        | 2000       | 60       |
|                 |                         | 2200            | 2249                    | 3450        | 402        | 2350        | 2400       | 60       |
| 2300            | 2351                    | 200             | 220                     | 950         | 279        | 1700        | 1200       | 60       |
|                 |                         | 600             | 617                     | 1400        | 315        | 1850        | 1400       | 60       |
|                 |                         | 1200            | 1229                    | 2150        | 388        | 2100        | 1800       | 60       |
|                 |                         | 1700            | 1739                    | 2800        | 391        | 2250        | 2100       | 60       |
|                 |                         | 2300            | 2351                    | 3550        | 414        | 2450        | 2500       | 60       |

Table contains selected branch sizes. For our full portfolio, please visit [www.amiblu.com/amiblu-products](http://www.amiblu.com/amiblu-products).  
 Sizes can be adapted to meet transport requirements. For project-related dimensions, please contact Amiblu.

Amiblu Holding GmbH | Pischeldorfer Str. 128 | 9020 Klagenfurt | Austria | +43 463 482424 | [www.amiblu.com](http://www.amiblu.com) | [info@amiblu.com](mailto:info@amiblu.com)

© Amiblu Holding GmbH. Figures may slightly vary due to manufacturing tolerances. Amiblu does not accept any liability for errors, omissions, and subsequent changes to technical data.

# y-Piece PN 1, 60°

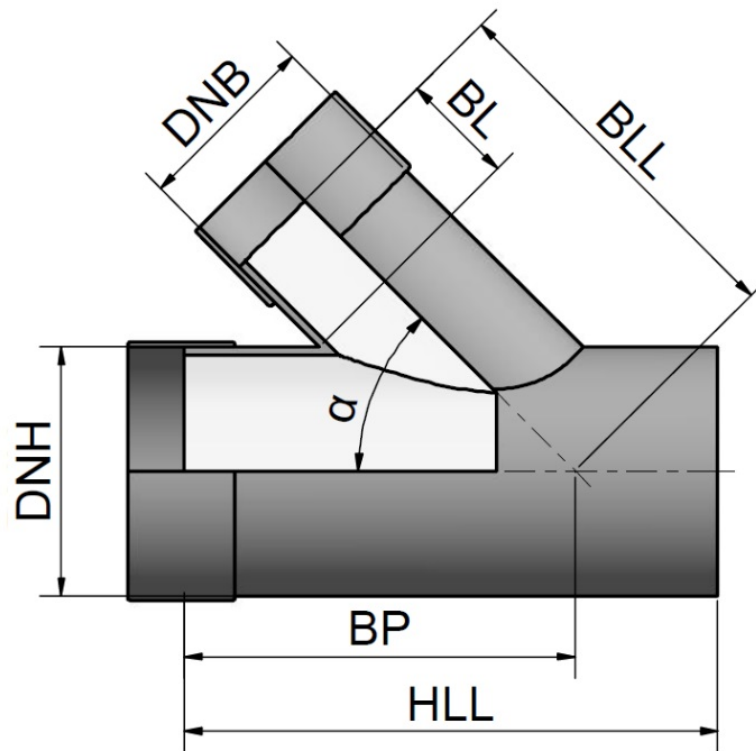

| DN <sub>H</sub> | d <sub>eH</sub><br>[mm] | DN <sub>B</sub> | d <sub>eB</sub><br>[mm] | HLL<br>[mm] | BL<br>[mm] | BLL<br>[mm] | BP<br>[mm] | α<br>[°] |
|-----------------|-------------------------|-----------------|-------------------------|-------------|------------|-------------|------------|----------|
| 2400            | 2453                    | 200             | 220                     | 950         | 270        | 1750        | 1200       | 60       |
|                 |                         | 600             | 617                     | 1400        | 356        | 1950        | 1450       | 60       |
|                 |                         | 1200            | 1229                    | 2150        | 379        | 2150        | 1800       | 60       |
|                 |                         | 1800            | 1841                    | 2900        | 402        | 2350        | 2200       | 60       |
|                 |                         | 2400            | 2453                    | 3700        | 426        | 2550        | 2600       | 60       |
| 2500            | 2555                    | 200             | 220                     | 950         | 261        | 1800        | 1250       | 60       |
|                 |                         | 600             | 617                     | 1400        | 347        | 2000        | 1450       | 60       |
|                 |                         | 1300            | 1331                    | 2300        | 341        | 2200        | 1900       | 60       |
|                 |                         | 1900            | 1943                    | 3050        | 414        | 2450        | 2300       | 60       |
|                 |                         | 2500            | 2555                    | 3800        | 437        | 2650        | 2650       | 60       |
| 2600            | 2657                    | 200             | 220                     | 950         | 303        | 1900        | 1250       | 60       |
|                 |                         | 600             | 617                     | 1450        | 338        | 2050        | 1500       | 60       |
|                 |                         | 1300            | 1331                    | 2300        | 382        | 2300        | 1950       | 60       |
|                 |                         | 1900            | 1943                    | 3100        | 405        | 2500        | 2350       | 60       |
|                 |                         | 2600            | 2657                    | 3950        | 449        | 2750        | 2750       | 60       |
| 2700            | 2759                    | 200             | 220                     | 950         | 294        | 1950        | 1300       | 60       |
|                 |                         | 700             | 719                     | 1550        | 350        | 2150        | 1600       | 60       |
|                 |                         | 1400            | 1433                    | 2450        | 393        | 2400        | 2050       | 60       |
|                 |                         | 2000            | 2045                    | 3200        | 417        | 2600        | 2400       | 60       |
|                 |                         | 2700            | 2759                    | 4100        | 461        | 2850        | 2850       | 60       |

Table contains selected branch sizes. For our full portfolio, please visit [www.amiblu.com/amiblu-products](http://www.amiblu.com/amiblu-products).  
 Sizes can be adapted to meet transport requirements. For project-related dimensions, please contact Amiblu.

Amiblu Holding GmbH | Pischeldorfer Str. 128 | 9020 Klagenfurt | Austria | +43 463 482424 | [www.amiblu.com](http://www.amiblu.com) | [info@amiblu.com](mailto:info@amiblu.com)

© Amiblu Holding GmbH. Figures may slightly vary due to manufacturing tolerances. Amiblu does not accept any liability for errors, omissions, and subsequent changes to technical data.

# y-Piece PN 1, 60°

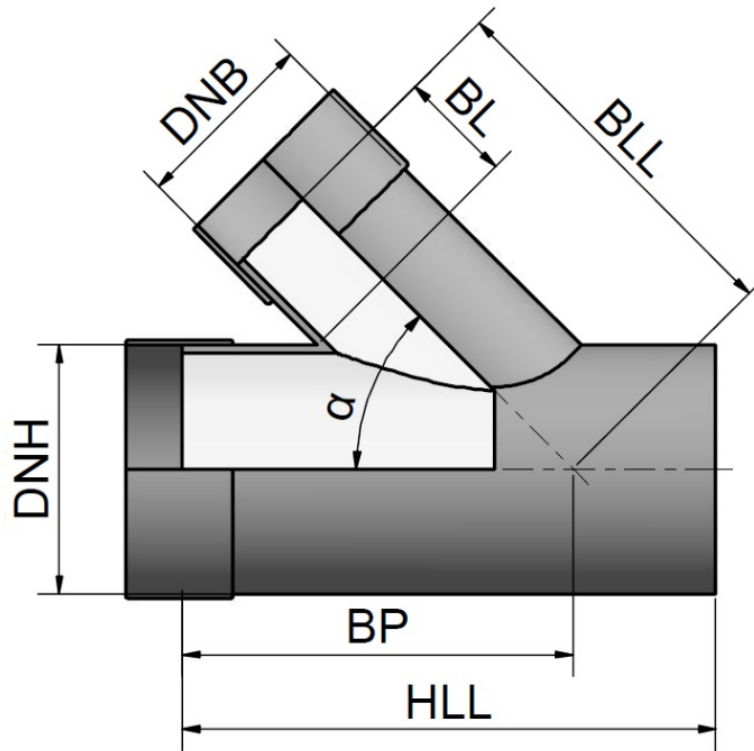

| DN <sub>H</sub> | d <sub>eH</sub><br>[mm] | DN <sub>B</sub> | d <sub>eB</sub><br>[mm] | HLL<br>[mm] | BL<br>[mm] | BLL<br>[mm] | BP<br>[mm] | α<br>[°] |
|-----------------|-------------------------|-----------------|-------------------------|-------------|------------|-------------|------------|----------|
| 2800            | 2861                    | 200             | 220                     | 950         | 285        | 2000        | 1350       | 60       |
|                 |                         | 700             | 719                     | 1550        | 341        | 2200        | 1650       | 60       |
|                 |                         | 1400            | 1433                    | 2450        | 385        | 2450        | 2100       | 60       |
|                 |                         | 2100            | 2147                    | 3350        | 428        | 2700        | 2550       | 60       |
|                 |                         | 2800            | 2861                    | 4250        | 472        | 2950        | 3000       | 60       |
| 2900            | 2963                    | 200             | 220                     | 950         | 276        | 2050        | 1350       | 60       |
|                 |                         | 700             | 719                     | 1550        | 332        | 2250        | 1650       | 60       |
|                 |                         | 1500            | 1535                    | 2600        | 396        | 2550        | 2200       | 60       |
|                 |                         | 2200            | 2249                    | 3450        | 440        | 2800        | 2600       | 60       |
|                 |                         | 2900            | 2963                    | 4350        | 484        | 3050        | 3050       | 60       |
| 3000            | 3065                    | 200             | 220                     | 950         | 267        | 2100        | 1400       | 60       |
|                 |                         | 700             | 719                     | 1550        | 323        | 2300        | 1700       | 60       |
|                 |                         | 1500            | 1535                    | 2600        | 387        | 2600        | 2200       | 60       |
|                 |                         | 2200            | 2249                    | 3450        | 431        | 2850        | 2650       | 60       |
|                 |                         | 3000            | 3065                    | 4450        | 496        | 3150        | 3150       | 60       |
| 3100            | 3167                    | 200             | 220                     | 950         | 308        | 2200        | 1400       | 60       |
|                 |                         | 800             | 821                     | 1700        | 335        | 2400        | 1800       | 60       |
|                 |                         | 1600            | 1637                    | 2700        | 399        | 2700        | 2300       | 60       |
|                 |                         | 2300            | 2351                    | 3600        | 443        | 2950        | 2750       | 60       |
|                 |                         | 3100            | 3167                    | 4600        | 507        | 3250        | 3250       | 60       |

Table contains selected branch sizes. For our full portfolio, please visit [www.amiblu.com/amiblu-products](http://www.amiblu.com/amiblu-products).

Sizes can be adapted to meet transport requirements. For project-related dimensions, please contact Amiblu.

Amiblu Holding GmbH | Pischeldorfer Str. 128 | 9020 Klagenfurt | Austria | +43 463 482424 | [www.amiblu.com](http://www.amiblu.com) | [info@amiblu.com](mailto:info@amiblu.com)

© Amiblu Holding GmbH. Figures may slightly vary due to manufacturing tolerances. Amiblu does not accept any liability for errors, omissions, and subsequent changes to technical data.

Publication: 05/2020

# y-Piece PN 1, 60°

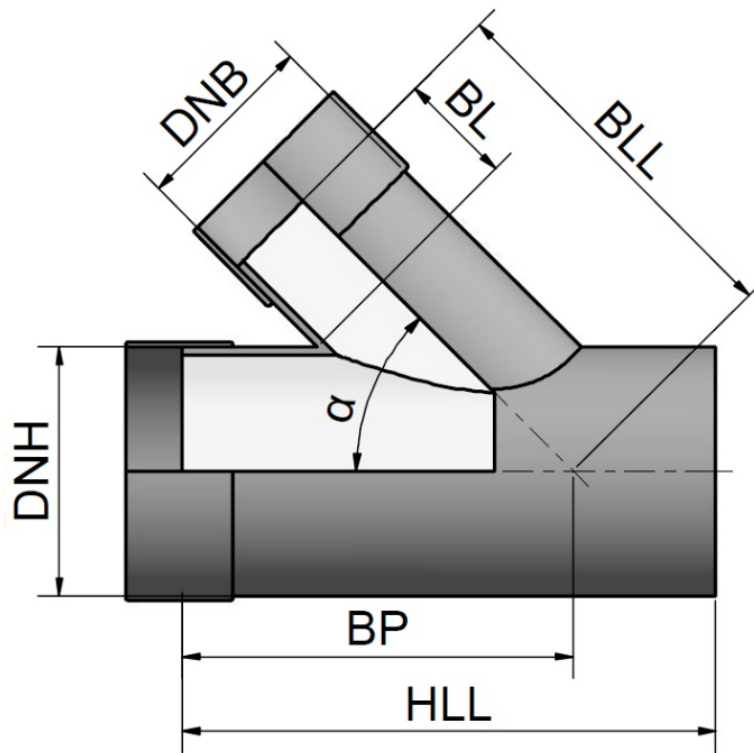

| DN <sub>H</sub> | d <sub>eH</sub><br>[mm] | DN <sub>B</sub> | d <sub>eB</sub><br>[mm] | HLL<br>[mm] | BL<br>[mm] | BLL<br>[mm] | BP<br>[mm] | α<br>[°] |
|-----------------|-------------------------|-----------------|-------------------------|-------------|------------|-------------|------------|----------|
| 3200            | 3269                    | 200             | 220                     | 950         | 299        | 2250        | 1450       | 60       |
|                 |                         | 800             | 821                     | 1700        | 326        | 2450        | 1800       | 60       |
|                 |                         | 1600            | 1637                    | 2700        | 390        | 2750        | 2300       | 60       |
|                 |                         | 2400            | 2453                    | 3750        | 455        | 3050        | 2850       | 60       |
|                 |                         | 3200            | 3269                    | 4750        | 469        | 3300        | 3350       | 60       |

Table contains selected branch sizes. For our full portfolio, please visit [www.amiblu.com/amiblu-products](http://www.amiblu.com/amiblu-products).  
 Sizes can be adapted to meet transport requirements. For project-related dimensions, please contact Amiblu.

Amiblu Holding GmbH | Pischeldorfer Str. 128 | 9020 Klagenfurt | Austria | +43 463 482424 | [www.amiblu.com](http://www.amiblu.com) | [info@amiblu.com](mailto:info@amiblu.com)

© Amiblu Holding GmbH. Figures may slightly vary due to manufacturing tolerances. Amiblu does not accept any liability for errors, omissions, and subsequent changes to technical data.

Publication: 05/2020



# Notes

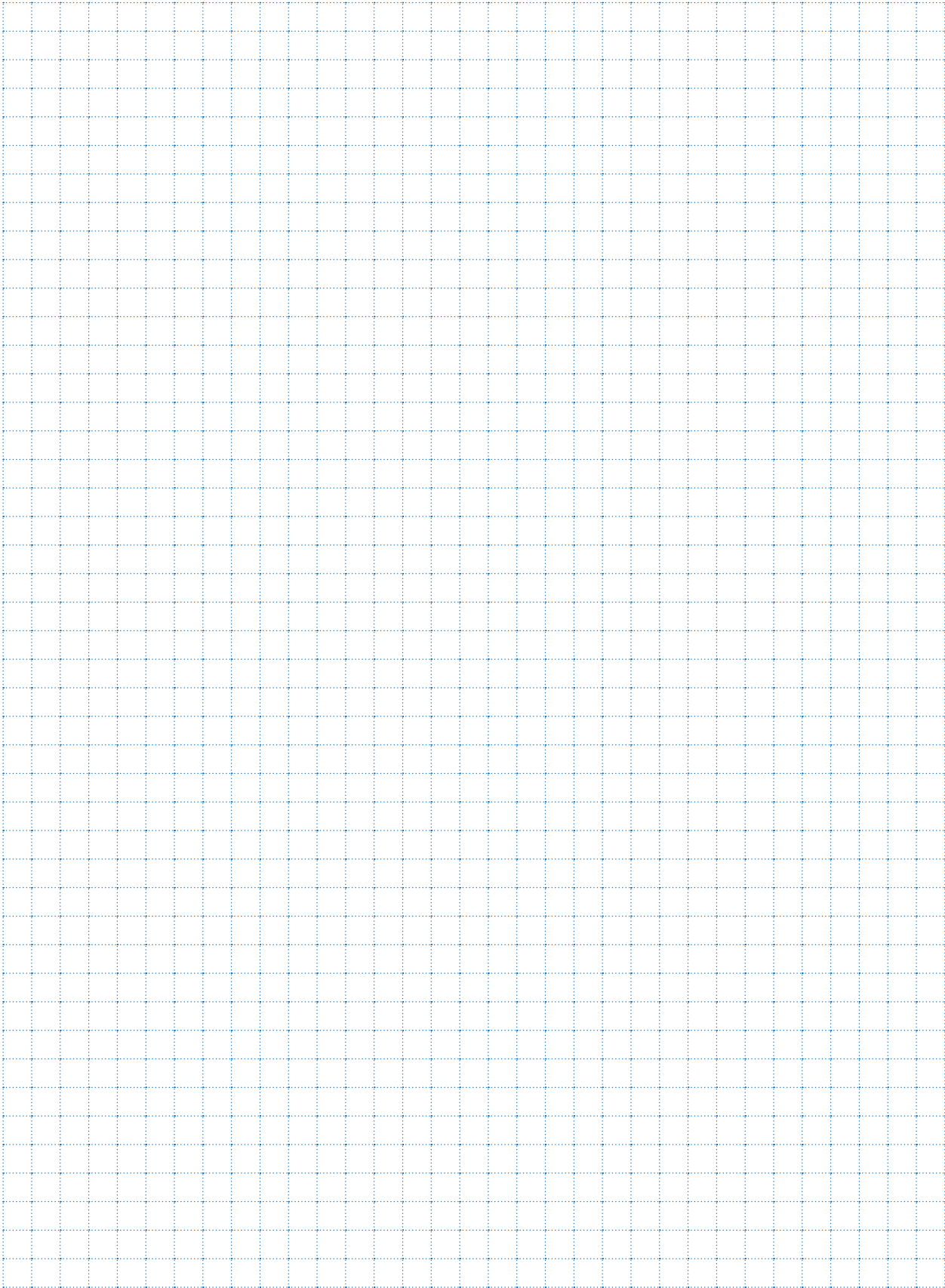

# Notes

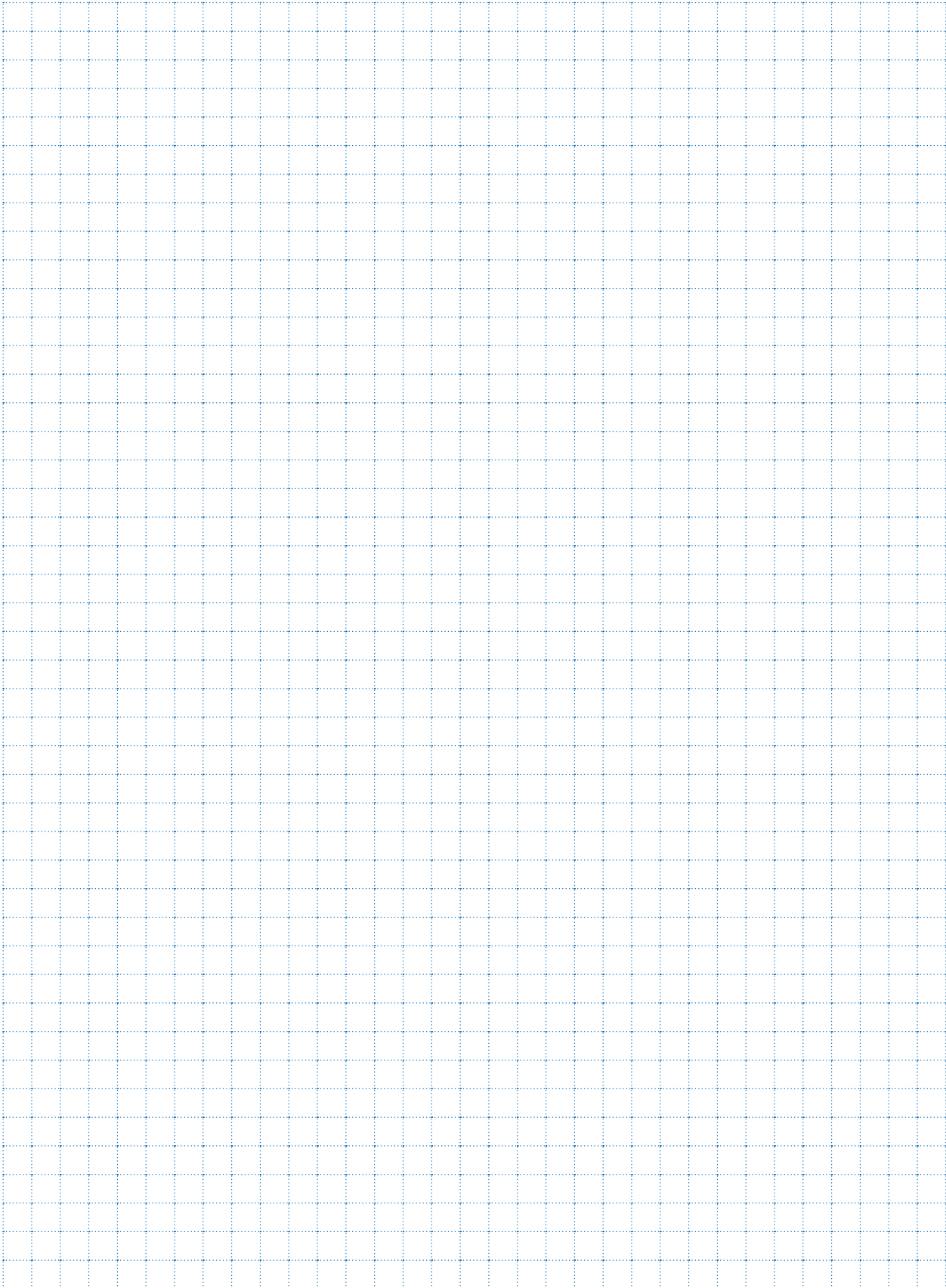

# Notes

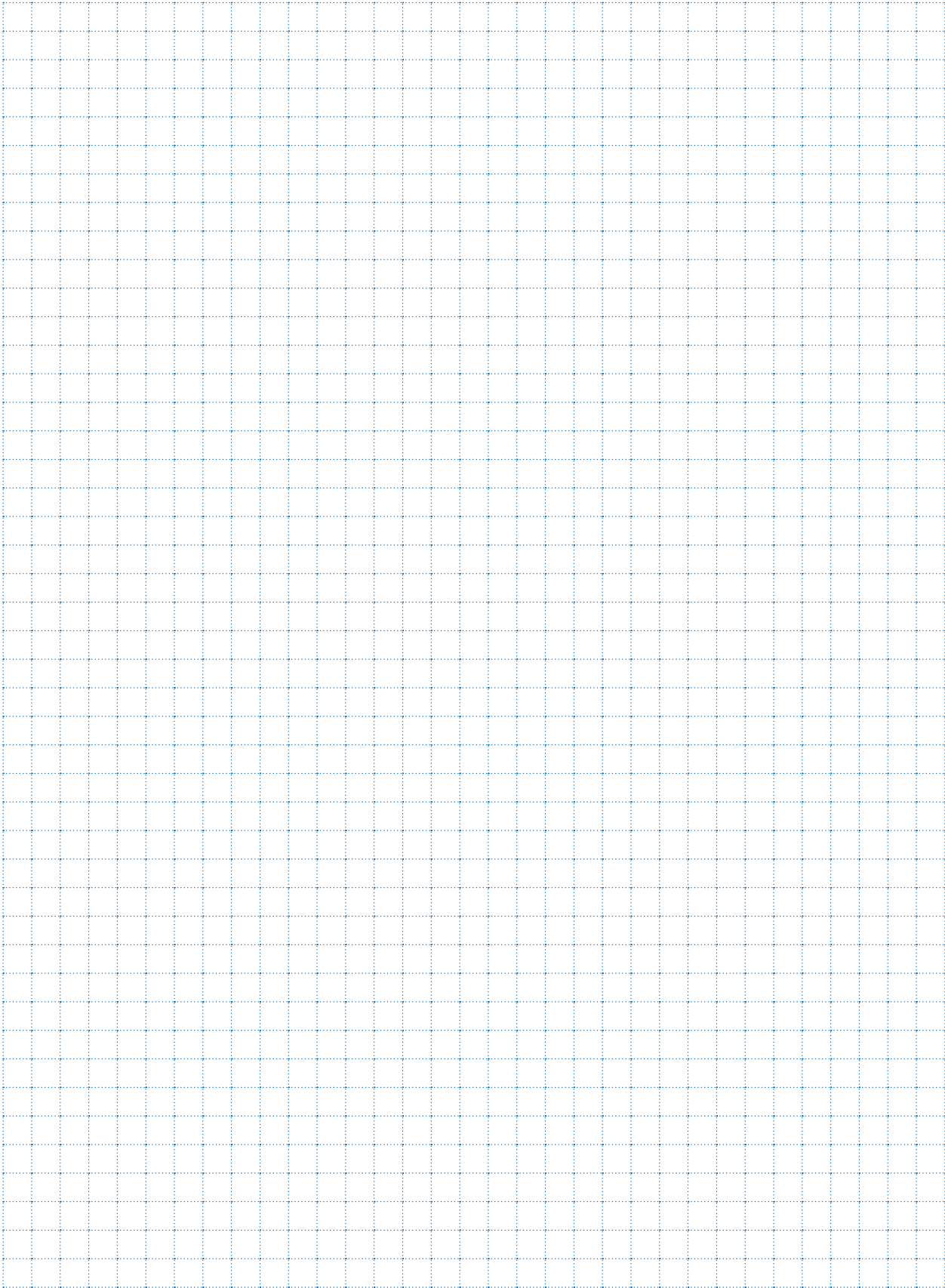

# Why there is nothing else like an Amiblu pipe system



Engineered for  
the next 150 years



Service-focused partners  
to solve your problems



Innovation to challenge  
the status quo



## Amiblu®

Explore more on [amiblu.com](https://www.amiblu.com) or contact your local partner for sustainable GRP pipe solutions.

All rights reserved. No part of this document may be reproduced in any form or by any means without prior written permission. All data, especially technical data, is subject to subsequent modifications. The given information is not binding and must therefore be checked and, if necessary, revised in each individual case. Amiblu and the companies affiliated with Amiblu are not liable for the advertising statements in this advertising brochure. In particular, Amiblu makes it clear that the advertising statements may not reflect the actual product characteristics and are for advertising purposes only, and therefore these statements do not form part of any contract for the purchase of the products advertised herein. © Amiblu Holding GmbH, Publication: 05/2020 | Rev. 1.3



Amiblu Pipe Systems  
Engineered for the next 150 years