

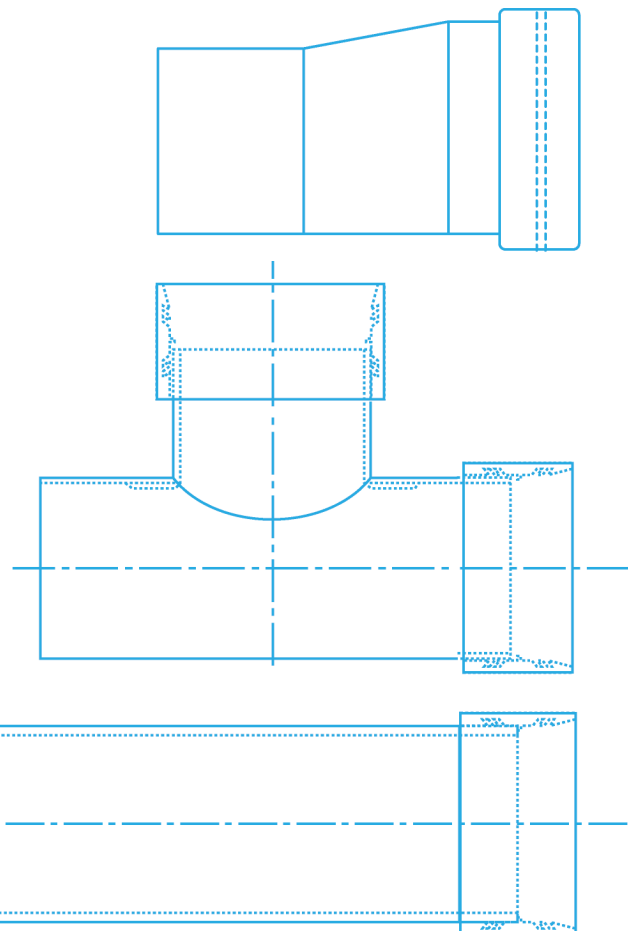

# Hobas GRP pipe systems PN 1

Technical product data

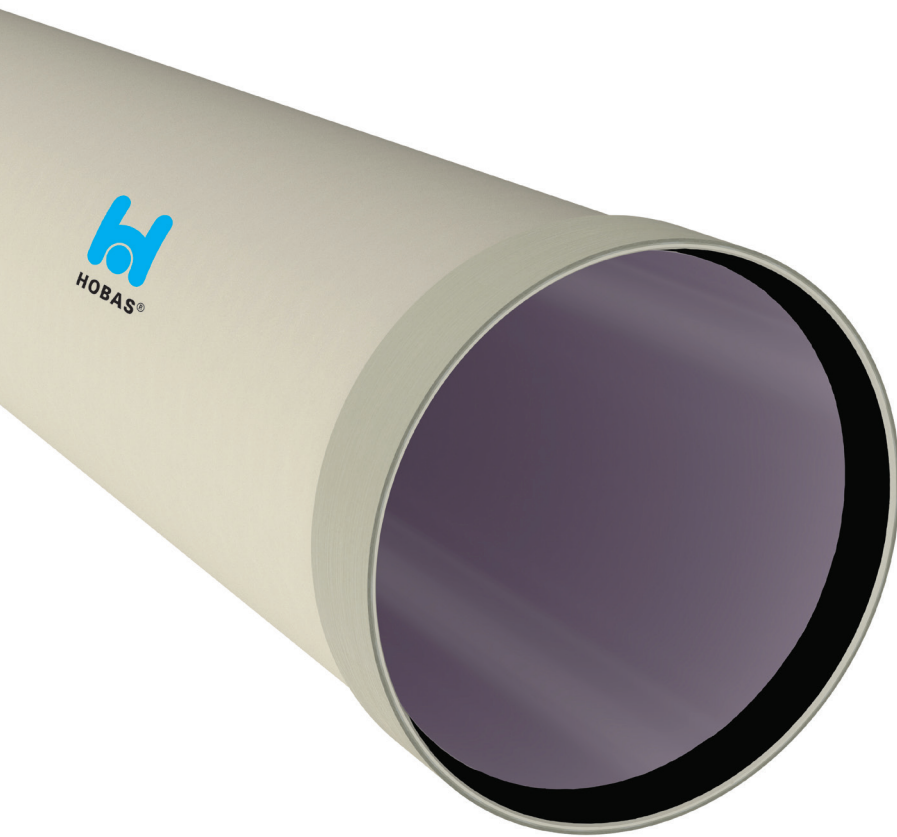



# Contents

	Page	
	4	Abbreviations
<b>PIPES</b>	5	Pipe PN 1
	7	Jacking Pipe
<b>PIPE JOINTS</b>	14	Hobas Filament Wound Coupling
	15	Joints and Couplings
<b>FITTINGS</b>	17	Segmented Elbow
	19	T-Piece Concentric
	28	T-Piece Eccentric
	37	Reducer
	39	y-Piece 45°
	48	y-Piece 60°
	57	Notes



This version replaces all previous versions. For all current data and values please visit [www.amiblu.com](http://www.amiblu.com).

# Abbreviations

$\alpha$	Angle
B1	$d_e$ to product standard (EN 1796/EN 14364)
B2	$d_e$ to GRP and casting standards
B3	$d_e$ to GRP and PVC standards
B4	$d_e$ to GRP and steel standards
BE	Branch eccentricity
BL	Branch length / Bend length
BLL	Branch laying length
BP	Branch position
$d_e$	External diameter
$d_{eB}$	External diameter branch
$d_{eH}$	External diameter header
$d_{eL}$	External diameter large
$d_{eS}$	External diameter small

DN	Nominal diameter
$DN_B$	Nominal diameter branch
$DN_H$	Nominal diameter header
$DN_L$	Nominal diameter large
$DN_S$	Nominal diameter small
DS	Diameter series
e	Wall thickness
HLL	Header laying length
LL	Laying length
LN	Nominal length
m	Weight
PN	Nominal pressure
R	Radius
SN	Nominal stiffness

# Pipe PN1

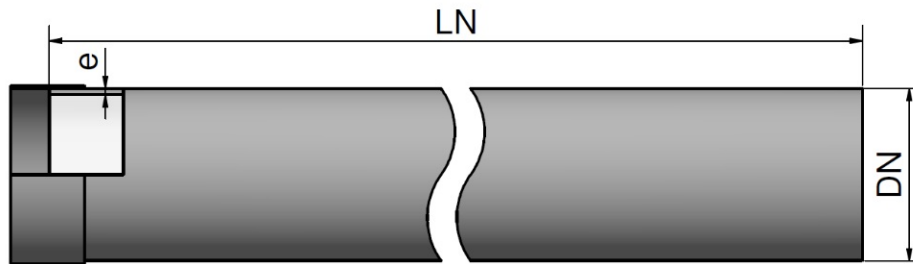

Portfolio as sold by Amiblu. For the full range of the Hobas technology, visit [www.hobas.com](http://www.hobas.com).

DN	DS	d <sub>e</sub> [mm]	SN 2500		SN 5000		SN 10000		SN 16000		SN 20000	
			m [kg/m]	e [mm]	m [kg/m]	e [mm]	m [kg/m]	e [mm]	m [kg/m]	e [mm]	m [kg/m]	e [mm]
200	B2	220					7	5	8	6	9	7
250	B2	272					11	6	12	7	13	8
300	B2	324					15	8	17	9	18	9
350	B2	376					20	9	23	10	25	10
400	B2	427					26	9	30	11	32	12
450	B2	478					30	10	35	12	38	13
500	B2	530					39	11	46	13	49	14
550	-	550	27	8	34	9	42	11	49	13	53	14
600	B1	616	33	9	42	10	53	13	62	15	66	16
650	-	650	37	9	47	11	59	13	69	16	73	17
700	B1	718	45	9	57	12	72	15	84	17	89	18
750	-	752	50	10	63	12	79	16	92	18	98	19
800	B1	820	59	11	74	13	94	17	109	19	116	21
860	-	860	65	11	82	14	103	18	120	20	128	22
900	B1	924	75	12	94	15	119	19	138	22	147	23
960	-	960	81	12	102	16	129	19	149	23	159	24
1000	B1	1026	93	14	117	17	148	21	171	24	182	26
1100	-	1099	106	14	135	18	170	22	196	26	209	28

The standard pipe lengths are 3 and 6 m. Other lengths are available on request.

Other stiffness classes are available on request.

The pipe design is tested for water jetting resistance according to DIN 19523. Please contact your representative for detailed information regarding requirements for water jetting.

# Pipe PN1

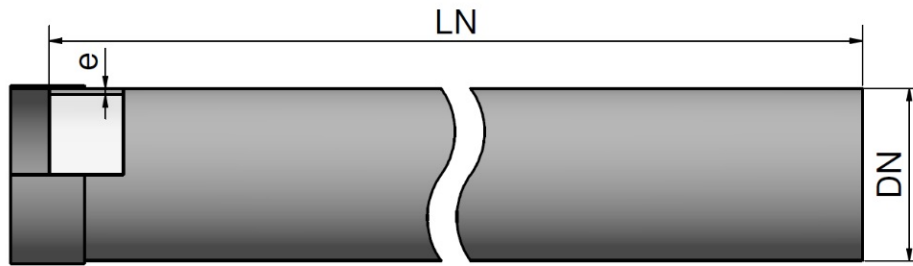

Portfolio as sold by Amiblu. For the full range of the Hobas technology, visit [www.hobas.com](http://www.hobas.com).

DN	DS	d <sub>e</sub> [mm]	SN 2500		SN 5000		SN 10000		SN 16000		SN 20000	
			m [kg/m]	e [mm]	m [kg/m]	e [mm]	m [kg/m]	e [mm]	m [kg/m]	e [mm]	m [kg/m]	e [mm]
1200	B1	1229	133	16	169	20	212	25	244	29	261	31
1280	-	1280	144	17	183	21	230	26	265	31	283	33
1400	B1	1434	181	18	229	23	288	29	331	34	355	37
1500	-	1499	198	19	251	24	315	31	362	36	387	38
1535	-	1535	209	20	265	25	334	32	383	37	410	40
1600	B1	1638	239	21	302	27	379	34	436	39	466	42
1720	-	1720	263	22	334	28	418	36	481	41	514	44
1800	B1	1842	302	24	383	30	479	38	550	44	588	47
1940	-	1937	334	25	423	32	529	40	609	46	651	50
2000	B1	2047	373	27	473	34	590	42	679	49	727	53
2160	-	2160	416	28	527	36	658	45	756	52	809	56
2200	B1	2250	451	29	572	37	713	47	820	54	877	58
2400	-	2400	515	31	653	40	812	50	934	58	1000	62
2453	-	2453	538	32	682	41	849	51	976	59	1044	63
2555	-	2555	584	33	741	42	920	53	1058	62	1131	66
3000	-	2999	805	39	1019	50	1263	62	1456	72	1558	78
3270	-	3270	958	43	1208	54	1500	68	1731	79	1852	85
3600	-	3600	1162	47	1462	60	1815	75	2094	87	2241	93

The standard pipe lengths are 3 and 6 m. Other lengths are available on request.

Other stiffness classes are available on request.

The pipe design is tested for water jetting resistance according to DIN 19523. Please contact your representative for detailed information regarding requirements for water jetting.

# Jacking Pipe PN 1

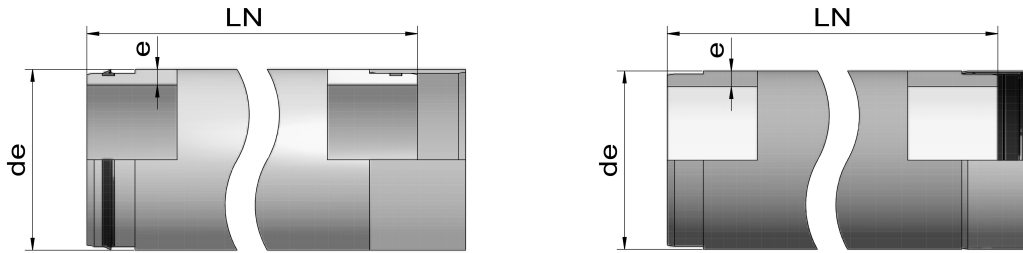

Portfolio as sold by Amiblu. For the full range of the Hobas technology, visit [www.hobas.com](http://www.hobas.com).

de [mm]		SN	SN	SN	SN	SN	SN	SN	SN	SN	SN	SN	SN
Coupling Type		32000	40000	50000	64000	80000	100000	128000	160000	200000	320000	640000	1000000
272	e [mm]										19	24	
Stainless Steel	m [kg/m]										32	40	
	F [kN]*										204	297	
324	e [mm]									20	23	28	
Stainless Steel	m [kg/m]									41	46	55	
	F [kN]*									273	341	452	
376	e [mm]							19	20	23	27	32	
Stainless Steel	m [kg/m]							46	48	54	63	74	
	F [kN]*							297	324	405	424	638	
427	e [mm]						19	20	21	24	28	34	39
Stainless Steel	m [kg/m]						52	54	57	65	75	89	101
	F [kN]*						342	373	405	497	618	795	938
478	e [mm]					21	23	25	27	29	33	41	46
Stainless Steel	m [kg/m]					64	70	76	81	87	98	119	132
	F [kN]*					449	519	588	657	725	859	1120	1278
530	e [mm]				20	23	24	26	28	31	36	44	51
Stainless Steel	m [kg/m]				68	78	81	88	94	103	119	143	163
	F [kN]*				459	577	616	694	770	885	1071	1362	1608

Standard pipe lengths LN are 1 | 2 | 3 | 6 m. - Other lengths and stiffness classes are available on request.

Tolerances according to Amiblu standard.

\* The specified jacking force [kN] corresponds to the ultimate jacking force with a 3.5-times safety factor according to ISO 25780.

# Jacking Pipe PN 1

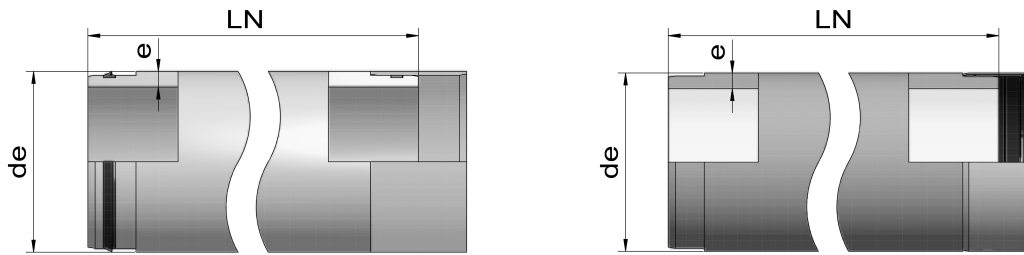

Portfolio as sold by Amiblu. For the full range of the Hobas technology, visit [www.hobas.com](http://www.hobas.com).

de [mm]		SN	SN	SN	SN	SN	SN	SN	SN	SN	SN	SN	SN
Coupling Type		32000	40000	50000	64000	80000	100000	128000	160000	200000	320000	640000	1000000
550	e [mm]		20	21	22	24	26	28	30	33	38	47	53
	m [kg/m]		71	74	78	84	91	98	104	114	130	158	176
	F [kN]*		484	525	566	648	728	808	888	1006	1199	1537	1755
616	e [mm]		21	23	25	27	29	32	34	37	43	50	58
	m [kg/m]		84	92	99	107	114	125	132	143	165	189	216
	F [kN]*		583	675	767	858	949	1083	1172	1304	1564	1860	2188
650	e [mm]	21	24	25	26	28	30	33	35	38	44	54	62
	m [kg/m]	89	101	105	109	117	125	136	144	156	178	215	243
	F [kN]*	613	760	809	857	953	1049	1191	1285	1425	1700	2146	2491
718	e [mm]	23	25	27	28	30	32	35	40	43	48	59	68
	m [kg/m]	108	117	125	130	139	147	160	182	194	215	260	295
	F [kN]*	733	842	949	1003	1109	1215	1373	1633	1787	2040	2583	3012
752	e [mm]	24	26	28	30	33	36	39	42	45	51	62	72
	m [kg/m]	118	127	136	145	159	173	186	200	213	239	286	327
	F [kN]*	800	913	1026	1138	1305	1470	1634	1797	1958	2276	2843	3342
820	e [mm]	25	27	29	33	35	38	42	45	49	54	67	78
	m [kg/m]	134	144	154	175	185	199	219	234	253	277	337	386
	F [kN]*	964	1088	1211	1456	1578	1758	1998	2175	2410	2699	3433	4033

Standard pipe lengths LN are 1 | 2 | 3 | 6 m. - Other lengths and stiffness classes are available on request.

Tolerances according to Amiblu standard.

\* The specified jacking force [kN] corresponds to the ultimate jacking force with a 3.5-times safety factor according to ISO 25780.



# Jacking Pipe PN 1

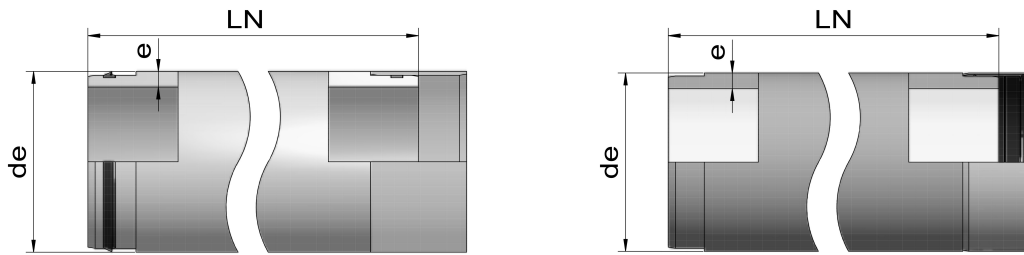

Portfolio as sold by Amiblu. For the full range of the Hobas technology, visit [www.hobas.com](http://www.hobas.com).

de [mm]		SN	SN	SN	SN	SN	SN	SN	SN	SN	SN	SN	SN
Coupling Type		32000	40000	50000	64000	80000	100000	128000	160000	200000	320000	640000	1000000
860	e [mm]	27	29	31	35	37	40	43	47	51	58	72	80
	m [kg/m]	152	162	173	194	205	220	236	256	276	311	379	417
	F [kN]*	1140	1270	1399	1655	1783	1972	2160	2409	2655	3080	3905	4362
924	e [mm]	29	32	34	37	40	42	46	50	54	62	77	
	m [kg/m]	175	192	204	221	238	249	271	293	315	358	436	
	F [kN]*	1302	1511	1649	1856	2061	2197	2466	2734	2998	3520	4470	
960	e [mm]	31	34	36	39	42	44	48	52	56	64	80	
	m [kg/m]	194	212	224	242	259	271	294	317	339	384	471	
	F [kN]*	1497	1714	1857	2072	2284	2425	2706	2983	3258	3801	4854	
1026	e [mm]	34	36	38	41	44	48	52	56	61	68		
	m [kg/m]	227	240	252	271	290	315	340	364	394	436		
	F [kN]*	1830	1984	2138	2367	2595	2897	3196	3492	3859	4366		
1099	e [mm]	35	38	41	44	48	51	56	59	64	73		
	m [kg/m]	251	272	292	312	339	359	392	411	444	501		
	F [kN]*	2040	2288	2535	2781	3106	3348	3748	3987	4380	5079		
1229	e [mm]	40	43	46	49	53	56	61	66	71	81		
	m [kg/m]	321	344	366	389	419	441	478	515	551	623		
	F [kN]*	2748	3026	3302	3576	3940	4212	4660	5105	5546	6415		

Standard pipe lengths LN are 1 | 2 | 3 | 6 m. - Other lengths and stiffness classes are available on request.

Tolerances according to Amiblu standard.

\* The specified jacking force [kN] corresponds to the ultimate jacking force with a 3.5-times safety factor according to ISO 25780.

# Jacking Pipe PN 1

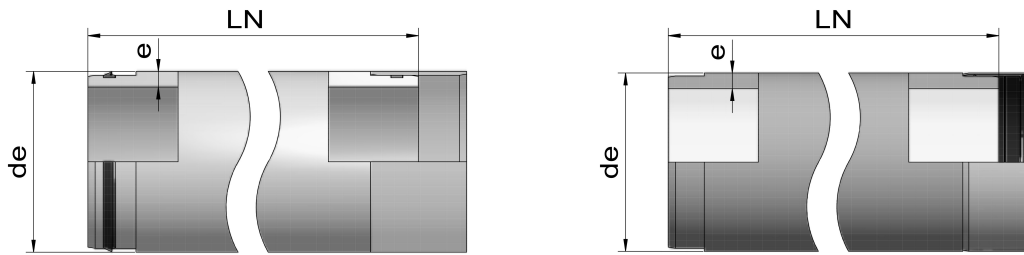

Portfolio as sold by Amiblu. For the full range of the Hobas technology, visit [www.hobas.com](http://www.hobas.com).

de [mm]		SN	SN	SN	SN	SN	SN	SN	SN	SN	SN	SN	SN
Coupling Type		32000	40000	50000	64000	80000	100000	128000	160000	200000	320000	640000	1000000
1280	e [mm]	41	45	47	52	55	59	64	68				
	m [kg/m]	343	375	391	430	453	484	522	553				
	F [kN]*	2968	3353	3545	4022	4306	4682	5149	5520				
Stainless Steel	e [mm]	46	49	52	57	61	65	71	76				
	m [kg/m]	431	458	485	529	564	598	650	693				
	F [kN]*	3890	4215	4537	5072	5497	5919	6548	7067				
1499	e [mm]	48	52	56	60	64	68	74	79				
	m [kg/m]	471	508	545	582	618	655	709	753				
	F [kN]*	4236	4688	5137	5583	6027	6469	7126	7669				
Stainless Steel	e [mm]	48	52	56	60	64	69	75					
	m [kg/m]	485	524	562	600	638	684	740					
	F [kN]*	3687	4151	4613	5072	5529	6096	6771					
1638	e [mm]	52	56	60	65	70	75	81					
	m [kg/m]	561	602	643	693	743	793	853					
	F [kN]*	4456	4949	5440	6051	6657	7259	7976					
Stainless Steel	e [mm]	55	59	64	68	73	78						
	m [kg/m]	623	666	719	762	815	867						
	F [kN]*	5065	5583	6227	6739	7376	8009						
1720	e [mm]	55	59	64	68	73	78						
	m [kg/m]	623	666	719	762	815	867						
	F [kN]*	5065	5583	6227	6739	7376	8009						
Stainless Steel	e [mm]	55	59	64	68	73	78						
	m [kg/m]	623	666	719	762	815	867						
	F [kN]*	5065	5583	6227	6739	7376	8009						

Standard pipe lengths LN are 1 | 2 | 3 | 6 m. - Other lengths and stiffness classes are available on request.

Tolerances according to Amiblu standard.

\* The specified jacking force [kN] corresponds to the ultimate jacking force with a 3.5-times safety factor according to ISO 25780.

# Jacking Pipe PN 1

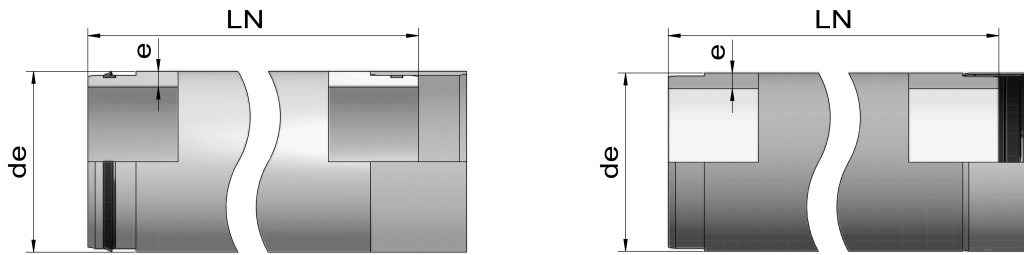

Portfolio as sold by Amiblu. For the full range of the Hobas technology, visit [www.hobas.com](http://www.hobas.com).

de [mm]		SN	SN	SN	SN	SN	SN	SN	SN	SN	SN	SN	SN
Coupling Type		32000	40000	50000	64000	80000	100000	128000	160000	200000	320000	640000	1000000
1842	e [mm]	59	63	68	73	78	83						
Stainless Steel	m [kg/m]	716	762	819	876	933	989						
	F [kN]*	6001	6557	7247	7934	8616	9295						
1937	e [mm]	62	67	72	77	81							
Stainless Steel	m [kg/m]	792	852	912	972	1019							
	F [kN]*	6747	7478	8204	8926	9501							
2047	e [mm]	65	70	75	81	85							
Stainless Steel	m [kg/m]	878	942	1005	1081	1131							
	F [kN]*	7601	8372	9139	10055	10662							
2160	e [mm]	69	74	79	85	90							
Stainless Steel	m [kg/m]	983	1051	1118	1198	1264							
	F [kN]*	8828	9641	10450	11416	12216							
2250	e [mm]	71	76	82	87	94							
Stainless Steel	m [kg/m]	1055	1125	1209	1279	1375							
	F [kN]*	9422	10271	11283	12123	13292							
2400	e [mm]	76	81	86	93	100							
GRP	m [kg/m]	1204	1279	1353	1457	1560							
	F [kN]*	9251	10154	11053	12304	13548							

Standard pipe lengths LN are 1 | 2 | 3 | 6 m. - Other lengths and stiffness classes are available on request.

Tolerances according to Amiblu standard.

\* The specified jacking force [kN] corresponds to the ultimate jacking force with a 3.5-times safety factor according to ISO 25780.

# Jacking Pipe PN 1

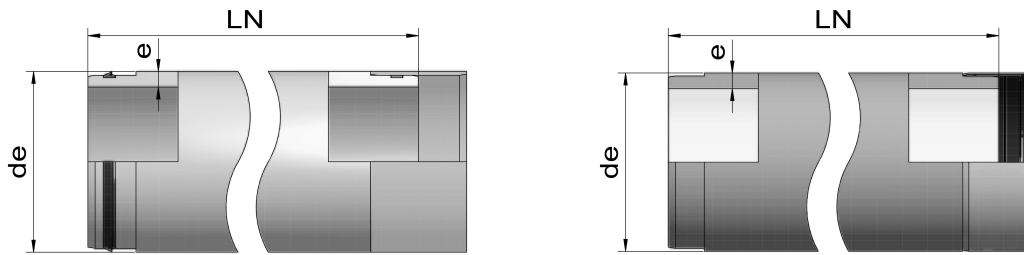

Portfolio as sold by Amiblu. For the full range of the Hobas technology, visit [www.hobas.com](http://www.hobas.com).

de [mm]		SN	SN	SN	SN	SN	SN	SN	SN	SN	SN	SN	SN
Coupling Type		32000	40000	50000	64000	80000	100000	128000	160000	200000	320000	640000	1000000
2453	e [mm]	80	82	88	95	102							
	m [kg/m]	1293	1324	1415	1521	1627							
	F [kN]*	10127	10497	11602	12884	14157							
GRP	e [mm]												
	m [kg/m]												
	F [kN]*												
2555	e [mm]	82	85	92	99	106							
	m [kg/m]	1382	1430	1541	1652	1762							
	F [kN]*	10846	11423	12765	14099	15425							
GRP	e [mm]												
	m [kg/m]												
	F [kN]*												
2999	e [mm]	94	100	108	117	127							
	m [kg/m]	1864	1976	2126	2292	2476							
	F [kN]*	13548	14907	16709	18724	20947							
GRP	e [mm]												
	m [kg/m]												
	F [kN]*												
3270	e [mm]	101	108	116	126								
	m [kg/m]	2187	2330	2492	2695								
	F [kN]*	15535	17265	19232	21676								
GRP	e [mm]												
	m [kg/m]												
	F [kN]*												
3600	e [mm]	111	119	128	138								
	m [kg/m]	2647	2827	3029	3251								
	F [kN]*	19774	21951	24388	27080								
GRP	e [mm]												
	m [kg/m]												
	F [kN]*												

Standard pipe lengths LN are 1 | 2 | 3 | 6 m. - Other lengths and stiffness classes are available on request.

Tolerances according to Amiblu standard.

\* The specified jacking force [kN] corresponds to the ultimate jacking force with a 3.5-times safety factor according to ISO 25780.

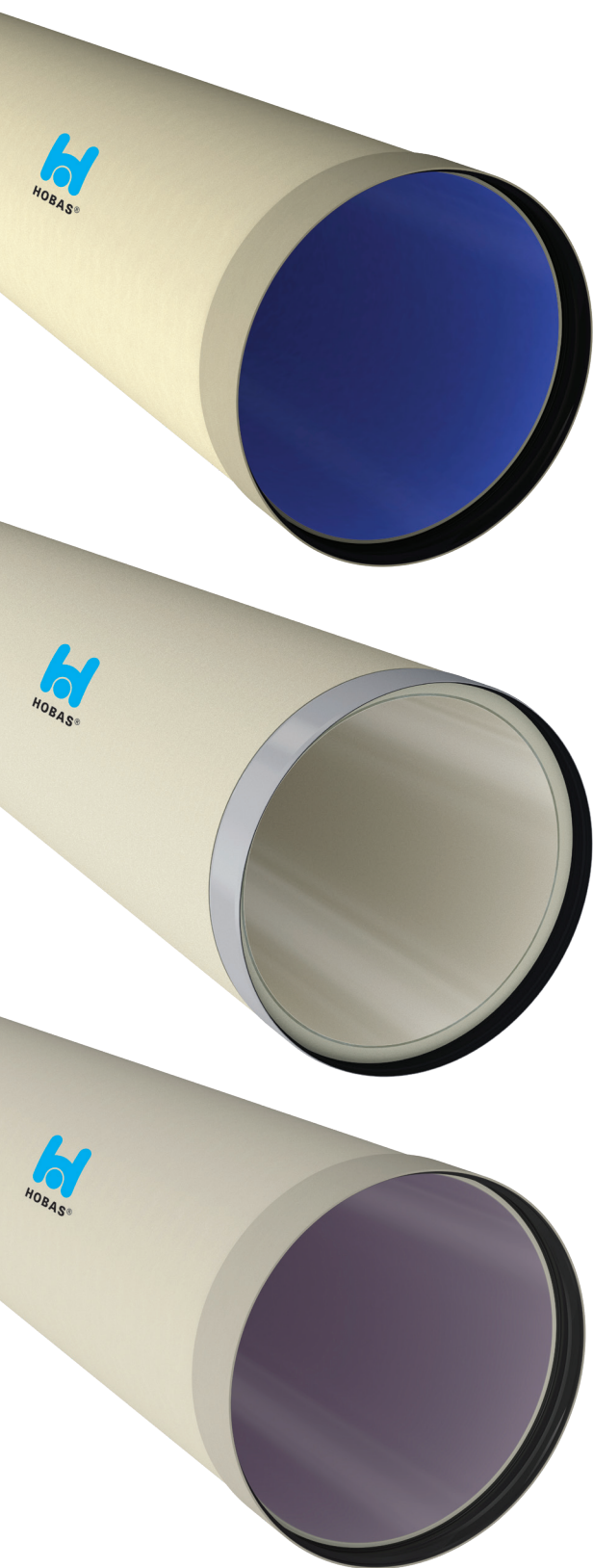

Amiblu offers a broad portfolio of centrifugally cast Hobas GRP pipe systems for various applications and installation methods, e.g. jacking pipes, relining pipes, special pipes with highly durable inner liner, and many more. For the complete range of offered products, please visit [www.amiblu.com](http://www.amiblu.com).

# Hobas Filament Wound Coupling (FWC) PN 1

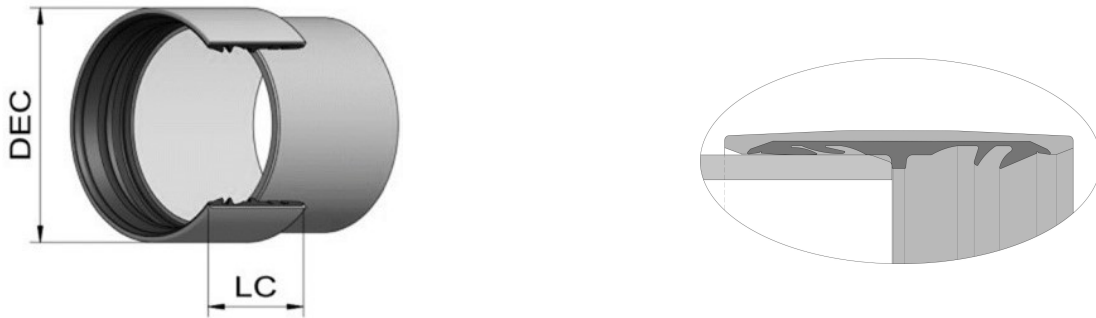

DN	De [mm]	LC [mm]	DEC min [mm]
200	220	173	240
250	272	173	291
300	324	173	343
350	376	173	395
400	427	230	448
450	478	230	498
500	530	230	551
550	550	230	571
600	616	230	641
650	650	230	672
700	718	230	739
750	752	230	773
800	820	230	843
860	860	230	883
900	924	230	947
960	960	230	983
1000	1026	230	1050

DN	De [mm]	LC [mm]	DEC min [mm]
1100	1099	230	1123
1200	1229	230	1256
1280	1280	230	1307
1400	1434	230	1464
1500	1499	310	1527
1535	1535	310	1565
1600	1638	310	1667
1720	1720	310	1749
1800	1842	310	1873
1940	1937	310	1971
2000	2047	310	2079
2160	2160	310	2196
2200	2250	310	2286
2400	2400	310	2435
2453	2453	310	2492
2555	2555	310	2595

Hobas pipes are generally delivered with a pre-mounted coupling. The standard pipe joint is the Hobas filament wound coupling, consisting of a GRP sleeve with a permanently fitted, full width EPDM gasket seal (NBR on request). Hobas filament wound couplings are available for all nominal pressure ratings.

## Joints and Couplings

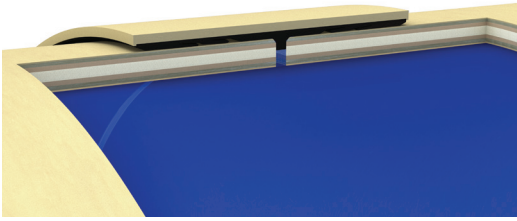

### Hobas Filament Wound Coupling (FWC)

Diameter range (DN): 200 - 2555 mm

Angular deflection\*: up to 3°

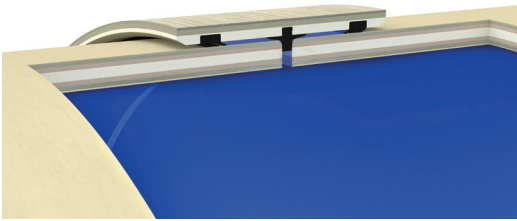

### Amiblu Non-pressure Coupling (ASC)

Diameter range (DN): 300 - 3600 mm

Angular deflection\*: up to 3°

\* The degree of angular deflection depends on the pipe diameter. Please contact Amiblu for further information.



### GRP Sleeve (GR)

Diameter range (de): 427 - 3600 mm

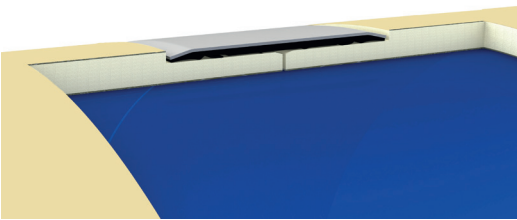

### Stainless Steel Sleeve With Integrated Rubber Seal (SE)

Diameter range (de): 272 - 2550 mm

### Field joints for pressure & gravity applications

Laminated field joints are available in uniaxial and biaxial designs. Amiblu provides the necessary instructions or skilled personnel for butt-wrap joining in pressure and non-pressure applications. Technologies developed by Amiblu provide faster and more cost-efficient installations.

### Masonry couplings

The masonry coupling is used for connecting pipes to concrete shafts and walls. Masonry couplings are sanded for improved stability in concrete shafts. Masonry couplings can be delivered with pipe ring, and optionally with sealing tape. Lengths can be selected as required in consideration of the pipe joint data.

### Mechanical couplings

Amiblu pipes can be joined using mechanical steel couplings such as tangential bolt couplings or axial bolt couplings.

### Amiblu flanges

Amiblu manufactures and sells flanges in various designs and according to different standards and requirements. When connecting two GRP flanges, the standard bolt pattern to which flanges are manufactured is EN 1092. Other bolting dimension systems such as according to AWWA, ANSI, DIN, and JIS can be supplied.



# Segmented Elbow PN 1

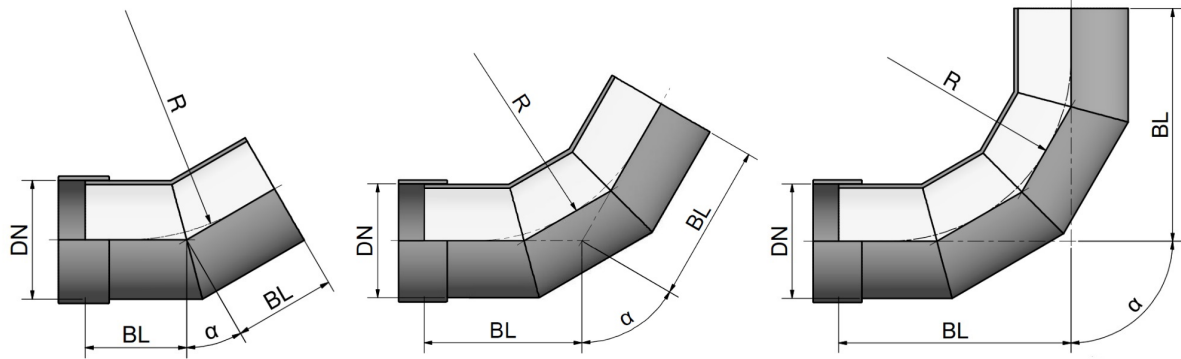

Angle $\alpha^*$ :		11.25°		15°		22.5°		30°		45°		60°		90°	
Segments:		2		2		2		2		3		3		4	
DN	$d_e$ [mm]	R [mm]	BL [mm]	R [mm]	BL [mm]	R [mm]	BL [mm]	R [mm]	BL [mm]	R [mm]	BL [mm]	R [mm]	BL [mm]	R [mm]	BL [mm]
200	220	300	250	300	250	300	250	300	250	300	300	300	350	300	500
250	272	375	250	375	250	375	250	375	250	375	350	375	400	375	550
300	324	450	300	450	300	450	300	450	300	450	400	450	450	450	650
350	376	525	300	525	300	525	300	525	300	525	400	525	500	525	700
400	427	600	350	600	350	600	350	600	350	600	450	600	500	600	750
450	478	675	350	675	350	675	350	675	350	675	450	675	550	675	850
500	530	750	350	750	350	750	350	750	350	750	500	750	600	750	900
550	550	825	350	825	350	825	350	825	350	825	500	825	600	825	950
600	616	900	350	900	350	900	350	900	350	900	550	900	650	900	1000
650	650	975	350	975	350	975	350	975	350	975	550	975	650	975	1100
700	718	1050	400	1050	400	1050	400	1050	400	1050	600	1050	700	1050	1150
750	752	1125	400	1125	400	1125	400	1125	400	1125	600	1125	750	1125	1200
800	820	1200	400	1200	400	1200	400	1200	400	1200	650	1200	800	1200	1300
860	860	1290	400	1290	400	1290	400	1290	400	1290	650	1290	800	1290	1350
900	924	1350	450	1350	450	1350	450	1350	450	1350	700	1350	850	1350	1400
960	960	1440	450	1440	450	1440	450	1440	450	1440	700	1440	900	1440	1500
1000	1026	1500	450	1500	450	1500	450	1500	450	1500	750	1500	900	1500	1550
1100	1099	1650	450	1650	450	1650	450	1650	450	1650	750	1650	950	1650	1650
1200	1229	1800	450	1800	450	1800	450	1800	450	1800	800	1800	1050	1800	1800
1280	1280	1920	500	1920	500	1920	500	1920	500	1920	850	1920	1100	1920	1900

\* For intermediate angles, the data of the respective next larger angle apply.

Sizes can be adapted to meet transport requirements. For project-related dimensions, please contact Amiblu.

Amiblu Holding GmbH | Pischeldorfer Str. 128 | 9020 Klagenfurt | Austria | +43 463 482424 | www.amiblu.com | info@amiblu.com

© Amiblu Holding GmbH. Figures may slightly vary due to manufacturing tolerances. Amiblu does not accept any liability for errors, omissions, and subsequent changes to technical data.

# Segmented Elbow PN 1

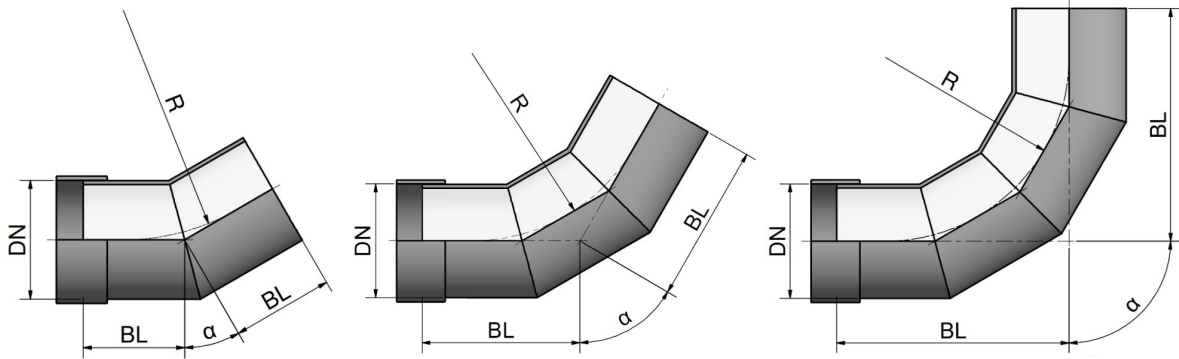

Angle $\alpha^*$ :		11.25°		15°		22.5°		30°		45°		60°		90°	
Segments:		2		2		2		2		3		3		4	
DN	$d_e$ [mm]	R [mm]	BL [mm]	R [mm]	BL [mm]	R [mm]	BL [mm]	R [mm]	BL [mm]	R [mm]	BL [mm]	R [mm]	BL [mm]	R [mm]	BL [mm]
1400	1434	2100	500	2100	500	2100	500	2100	500	2100	950	2100	1150	2100	2050
1500	1499	2250	550	2250	550	2250	550	2250	550	2250	1000	2250	1250	2250	2200
1535	1535	2303	550	2303	550	2303	550	2303	550	2303	1000	2303	1250	2303	2200
1600	1638	2400	550	2400	550	2400	550	2400	550	2400	1050	2400	1300	2400	2350
1720	1720	2580	600	2580	600	2580	600	2580	600	2580	1100	2580	1400	2580	2500
1800	1842	2700	600	2700	600	2700	600	2700	600	2700	1150	2700	1450	2700	2600
1940	1937	2910	650	2910	650	2910	650	2910	650	2910	1200	2910	1550	2910	2750
2000	2047	3000	650	3000	650	3000	650	3000	650	3000	1200	3000	1600	3000	2850
2160	2160	3240	650	3240	650	3240	650	3240	650	3240	1300	3240	1650	3240	3050
2200	2250	3300	700	3300	700	3300	700	3300	700	3300	1300	3300	1700	3300	3100
2400	2400	3600	700	3600	700	3600	700	3600	700	3600	1400	3600	1800	3600	3350
2453	2453	3680	700	3680	700	3680	700	3680	700	3680	1400	3680	1800	3680	3350
2555	2555	3833	750	3833	750	3833	750	3833	750	3833	1450	3833	1900	3833	3450
3000	2999	4500	850	4500	850	4500	850	4500	850	4500	1700	4500	2250	4500	4150
3270	3270	4905	900	4905	900	4905	900	4905	900	4905	1800	4905	2350	4905	4400
3600	3600	5400	1050	5400	1050	5400	1050	5400	1050	5400	2100	5400	2700	5400	5000

\* For intermediate angles, the data of the respective next larger angle apply.

Sizes can be adapted to meet transport requirements. For project-related dimensions, please contact Amiblu.

Amiblu Holding GmbH | Pischeldorfer Str. 128 | 9020 Klagenfurt | Austria | +43 463 482424 | www.amiblu.com | info@amiblu.com

© Amiblu Holding GmbH. Figures may slightly vary due to manufacturing tolerances. Amiblu does not accept any liability for errors, omissions, and subsequent changes to technical data.

# T-Piece Concentric PN 1

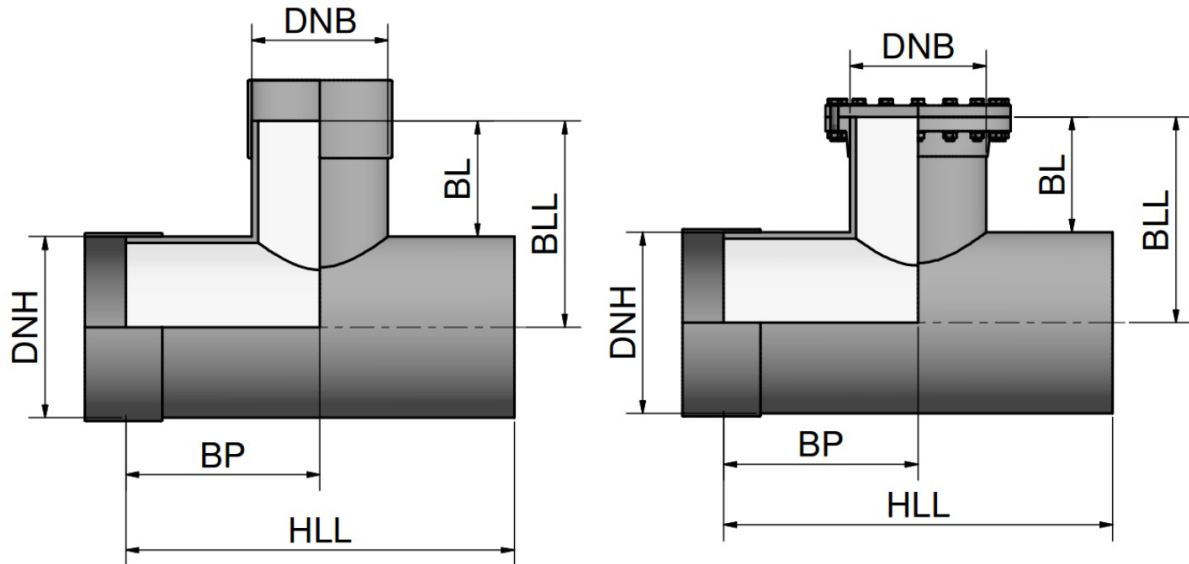

DN <sub>H</sub>	d <sub>eH</sub> [mm]	DN <sub>B</sub>	d <sub>eB</sub> [mm]	HLL [mm]	BL [mm]	BLL [mm]	BP [mm]
200	220	200	220	650	240	350	325
250	272	200	220	650	214	350	325
		250	272	700	214	350	350
300	324	200	220	750	238	400	375
		250	272	800	238	400	400
		300	324	850	288	450	425
350	376	200	220	750	212	400	375
		250	272	800	212	400	400
		300	324	850	262	450	425
		350	376	900	262	450	450
400	427	200	220	750	236	450	375
		250	272	800	236	450	400
		300	324	850	286	500	425
		350	376	900	286	500	450
		400	427	950	286	500	475

Table contains selected branch sizes. For our full portfolio, please visit [www.amiblu.com/amiblu-products](http://www.amiblu.com/amiblu-products).

Sizes can be adapted to meet transport requirements. For project-related dimensions, please contact Amiblu.

Amiblu Holding GmbH | Pischeldorfer Str. 128 | 9020 Klagenfurt | Austria | +43 463 482424 | [www.amiblu.com](http://www.amiblu.com) | [info@amiblu.com](mailto:info@amiblu.com)

© Amiblu Holding GmbH. Figures may slightly vary due to manufacturing tolerances. Amiblu does not accept any liability for errors, omissions, and subsequent changes to technical data.

# T-Piece Concentric PN 1

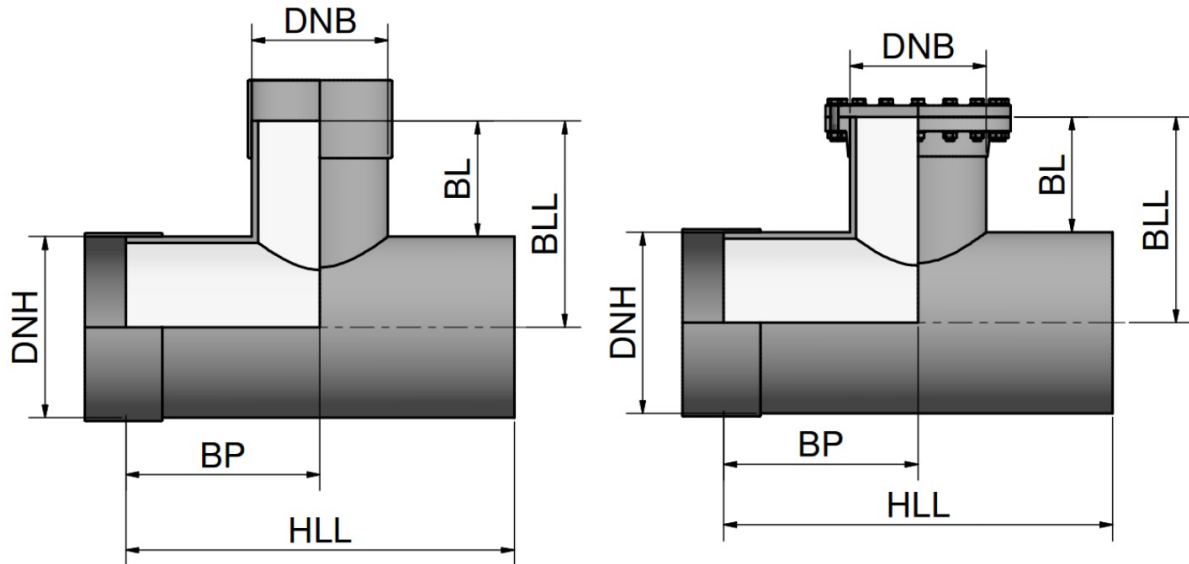

DN <sub>H</sub>	d <sub>eH</sub> [mm]	DN <sub>B</sub>	d <sub>eB</sub> [mm]	HLL [mm]	BL [mm]	BLL [mm]	BP [mm]
450	478	200	220	750	211	450	375
		300	324	850	261	500	425
		350	376	900	261	500	450
		400	427	950	261	500	475
		450	478	1000	261	500	500
500	530	200	220	750	235	500	375
		300	324	850	285	550	425
		400	427	950	285	550	475
		450	478	1000	285	550	500
		500	530	1050	285	550	525
550	550	200	220	750	225	500	375
		300	324	850	275	550	425
		400	427	950	275	550	475
		450	478	1000	275	550	500
		550	550	1100	275	550	550
600	616	200	220	750	242	550	375
		350	376	950	292	600	475
		450	478	1050	292	600	525
		500	530	1100	292	600	550
		600	616	1150	292	600	575

Table contains selected branch sizes. For our full portfolio, please visit [www.amiblu.com/amiblu-products](http://www.amiblu.com/amiblu-products).

Sizes can be adapted to meet transport requirements. For project-related dimensions, please contact Amiblu.

Amiblu Holding GmbH | Pischeldorfer Str. 128 | 9020 Klagenfurt | Austria | +43 463 482424 | [www.amiblu.com](http://www.amiblu.com) | [info@amiblu.com](mailto:info@amiblu.com)

© Amiblu Holding GmbH. Figures may slightly vary due to manufacturing tolerances. Amiblu does not accept any liability for errors, omissions, and subsequent changes to technical data.

# T-Piece Concentric PN 1

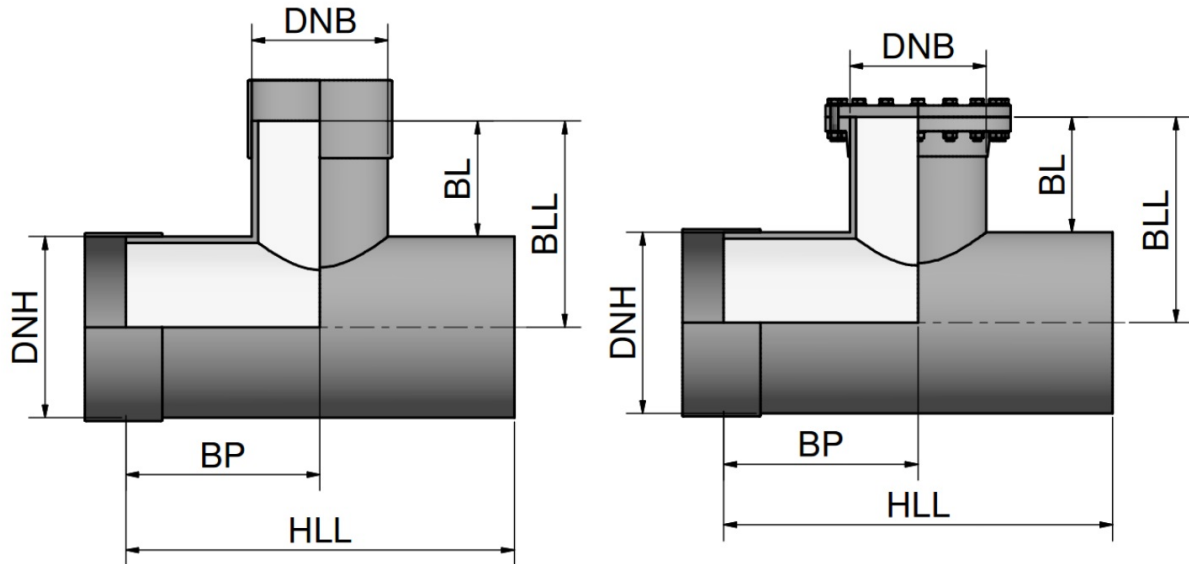

DN <sub>H</sub>	d <sub>eH</sub> [mm]	DN <sub>B</sub>	d <sub>eB</sub> [mm]	HLL [mm]	BL [mm]	BLL [mm]	BP [mm]
650	650	200	220	750	225	550	375
		350	376	950	275	600	475
		450	478	1050	275	600	525
		550	550	1100	275	600	550
		650	650	1200	275	600	600
700	718	200	220	750	241	600	375
		350	376	950	291	650	475
		500	530	1100	291	650	550
		600	616	1150	291	650	575
		700	718	1300	291	650	650
750	752	200	220	750	224	600	375
		350	376	950	274	650	475
		500	530	1100	274	650	550
		600	616	1150	274	650	575
		750	752	1300	274	650	650
800	820	200	220	750	240	650	375
		400	427	1000	290	700	500
		550	550	1100	290	700	550
		650	650	1200	290	700	600
		800	820	1400	290	700	700

Table contains selected branch sizes. For our full portfolio, please visit [www.amiblu.com/amiblu-products](http://www.amiblu.com/amiblu-products).

Sizes can be adapted to meet transport requirements. For project-related dimensions, please contact Amiblu.

Amiblu Holding GmbH | Pischeldorfer Str. 128 | 9020 Klagenfurt | Austria | +43 463 482424 | [www.amiblu.com](http://www.amiblu.com) | [info@amiblu.com](mailto:info@amiblu.com)

© Amiblu Holding GmbH. Figures may slightly vary due to manufacturing tolerances. Amiblu does not accept any liability for errors, omissions, and subsequent changes to technical data.

# T-Piece Concentric PN 1

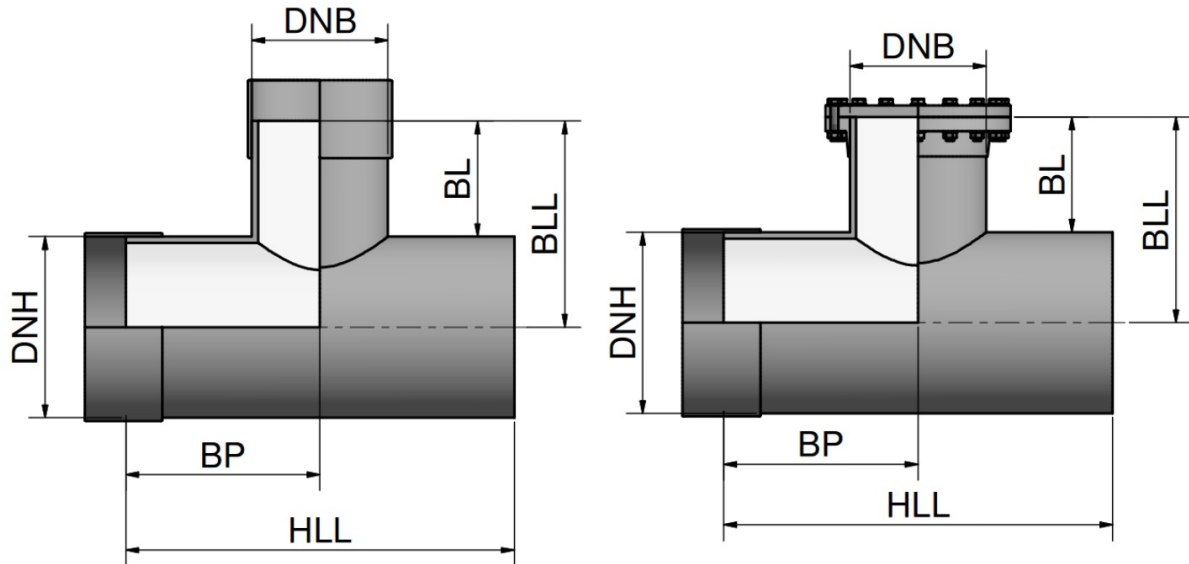

DN <sub>H</sub>	d <sub>eH</sub> [mm]	DN <sub>B</sub>	d <sub>eB</sub> [mm]	HLL [mm]	BL [mm]	BLL [mm]	BP [mm]
860	860	200	220	750	220	650	375
		400	427	1000	270	700	500
		550	550	1100	270	700	550
		700	718	1300	320	750	650
		860	860	1450	320	750	725
900	924	200	220	750	238	700	375
		400	427	1000	288	750	500
		600	616	1150	288	750	575
		750	752	1300	288	750	650
		900	924	1500	288	750	750
960	960	200	220	750	220	700	375
		400	427	1000	270	750	500
		600	616	1150	270	750	575
		750	752	1300	320	800	650
		960	960	1550	320	800	775
1000	1026	200	220	750	237	750	375
		450	478	1050	287	800	525
		650	650	1200	287	800	600
		800	820	1400	287	800	700
		1000	1026	1600	287	800	800

Table contains selected branch sizes. For our full portfolio, please visit [www.amiblu.com/amiblu-products](http://www.amiblu.com/amiblu-products).

Sizes can be adapted to meet transport requirements. For project-related dimensions, please contact Amiblu.

Amiblu Holding GmbH | Pischeldorfer Str. 128 | 9020 Klagenfurt | Austria | +43 463 482424 | [www.amiblu.com](http://www.amiblu.com) | [info@amiblu.com](mailto:info@amiblu.com)

© Amiblu Holding GmbH. Figures may slightly vary due to manufacturing tolerances. Amiblu does not accept any liability for errors, omissions, and subsequent changes to technical data.

# T-Piece Concentric PN 1

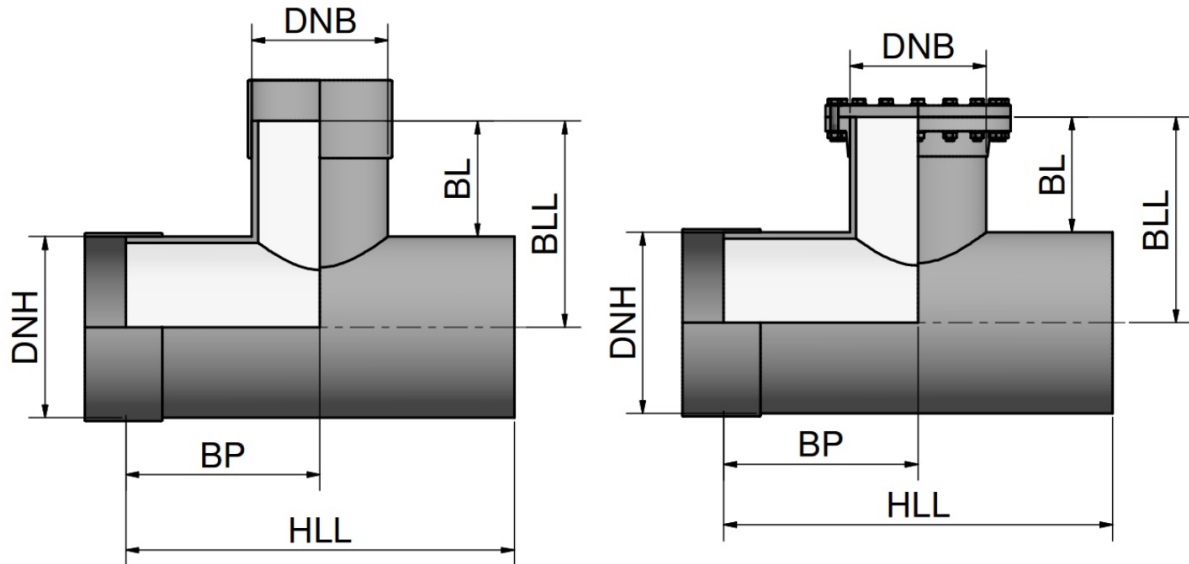

DN <sub>H</sub>	d <sub>eH</sub> [mm]	DN <sub>B</sub>	d <sub>eB</sub> [mm]	HLL [mm]	BL [mm]	BLL [mm]	BP [mm]
1100	1099	200	220	750	250	800	375
		450	478	1050	300	850	525
		650	650	1200	300	850	600
		860	860	1450	300	850	725
		1100	1099	1700	300	850	850
1200	1229	200	220	750	235	850	375
		450	478	1050	285	900	525
		700	718	1300	285	900	650
		900	924	1500	285	900	750
		1200	1229	1850	335	950	925
1280	1280	200	220	750	210	850	375
		450	478	1050	260	900	525
		700	718	1300	310	950	650
		900	924	1500	310	950	750
		1280	1280	1900	310	950	950
1400	1434	200	220	750	233	950	375
		500	530	1100	283	1000	550
		750	752	1300	283	1000	650
		960	960	1550	283	1000	775
		1400	1434	2050	333	1050	1025

Table contains selected branch sizes. For our full portfolio, please visit [www.amiblu.com/amiblu-products](http://www.amiblu.com/amiblu-products).

Sizes can be adapted to meet transport requirements. For project-related dimensions, please contact Amiblu.

Amiblu Holding GmbH | Pischeldorfer Str. 128 | 9020 Klagenfurt | Austria | +43 463 482424 | [www.amiblu.com](http://www.amiblu.com) | [info@amiblu.com](mailto:info@amiblu.com)

© Amiblu Holding GmbH. Figures may slightly vary due to manufacturing tolerances. Amiblu does not accept any liability for errors, omissions, and subsequent changes to technical data.

# T-Piece Concentric PN 1

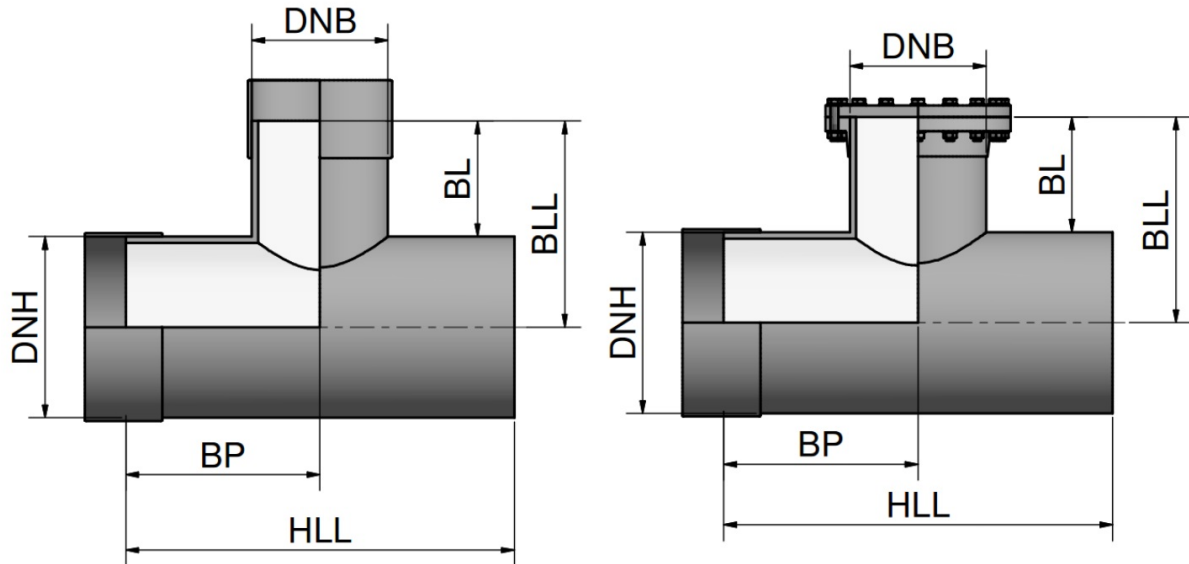

DN <sub>H</sub>	d <sub>eH</sub> [mm]	DN <sub>B</sub>	d <sub>eB</sub> [mm]	HLL [mm]	BL [mm]	BLL [mm]	BP [mm]
1500	1499	200	220	800	250	1000	400
		500	530	1150	300	1050	575
		750	752	1350	300	1050	675
		1000	1026	1650	300	1050	825
		1500	1499	2200	350	1100	1100
1535	1535	200	220	800	232	1000	400
		500	530	1150	282	1050	575
		800	820	1450	282	1050	725
		1100	1099	1750	332	1100	875
		1535	1535	2200	332	1100	1100
1600	1638	200	220	800	231	1050	400
		500	530	1150	281	1100	575
		800	820	1450	281	1100	725
		1100	1099	1750	331	1150	875
		1600	1638	2300	331	1150	1150
1720	1720	200	220	800	240	1100	400
		550	550	1150	290	1150	575
		860	860	1450	290	1150	725
		1200	1229	1850	290	1150	925
		1720	1720	2400	340	1200	1200

Table contains selected branch sizes. For our full portfolio, please visit [www.amiblu.com/amiblu-products](http://www.amiblu.com/amiblu-products).

Sizes can be adapted to meet transport requirements. For project-related dimensions, please contact Amiblu.

Amiblu Holding GmbH | Pischeldorfer Str. 128 | 9020 Klagenfurt | Austria | +43 463 482424 | [www.amiblu.com](http://www.amiblu.com) | [info@amiblu.com](mailto:info@amiblu.com)

© Amiblu Holding GmbH. Figures may slightly vary due to manufacturing tolerances. Amiblu does not accept any liability for errors, omissions, and subsequent changes to technical data.



# T-Piece Concentric PN 1

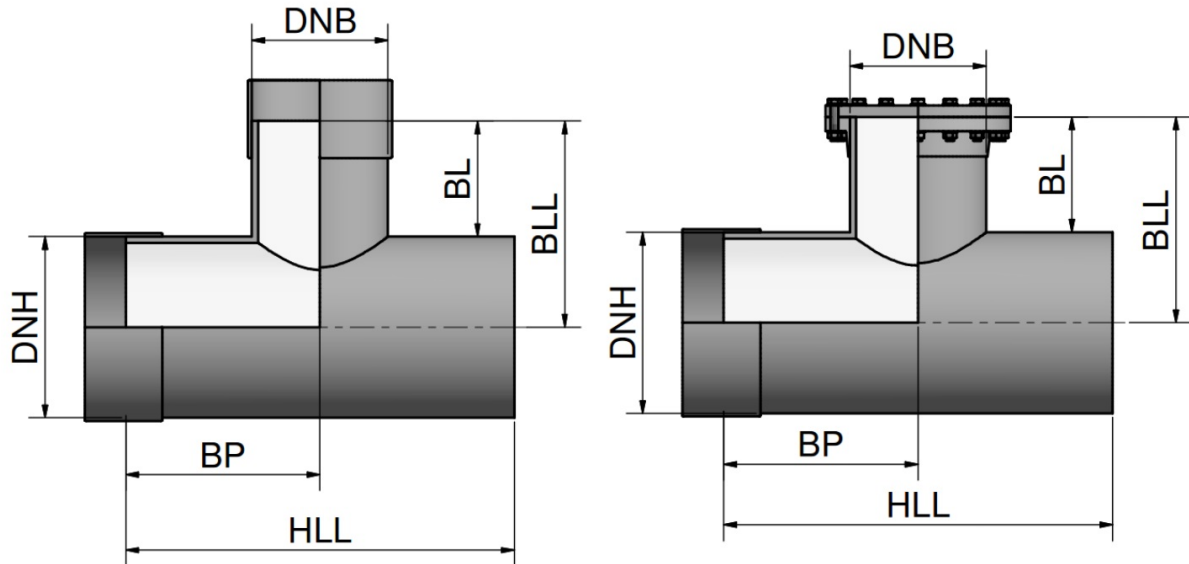

DN <sub>H</sub>	d <sub>eH</sub> [mm]	DN <sub>B</sub>	d <sub>eB</sub> [mm]	HLL [mm]	BL [mm]	BLL [mm]	BP [mm]
1800	1842	200	220	800	229	1150	400
		550	550	1150	279	1200	575
		860	860	1450	279	1200	725
		1280	1280	1950	329	1250	975
		1800	1842	2550	379	1300	1275
1940	1937	200	220	800	231	1200	400
		550	550	1150	281	1250	575
		900	924	1550	281	1250	775
		1400	1434	2100	331	1300	1050
		1940	1937	2650	381	1350	1325
2000	2047	200	220	800	226	1250	400
		550	550	1150	276	1300	575
		900	924	1550	276	1300	775
		1400	1434	2100	326	1350	1050
		2000	2047	2750	376	1400	1375
2160	2160	200	220	800	220	1300	400
		600	616	1200	270	1350	600
		960	960	1550	320	1400	775
		1500	1499	2200	370	1450	1100
		2160	2160	2900	370	1450	1450

Table contains selected branch sizes. For our full portfolio, please visit [www.amiblu.com/amiblu-products](http://www.amiblu.com/amiblu-products).

Sizes can be adapted to meet transport requirements. For project-related dimensions, please contact Amiblu.

Amiblu Holding GmbH | Pischeldorfer Str. 128 | 9020 Klagenfurt | Austria | +43 463 482424 | [www.amiblu.com](http://www.amiblu.com) | [info@amiblu.com](mailto:info@amiblu.com)

© Amiblu Holding GmbH. Figures may slightly vary due to manufacturing tolerances. Amiblu does not accept any liability for errors, omissions, and subsequent changes to technical data.

# T-Piece Concentric PN 1

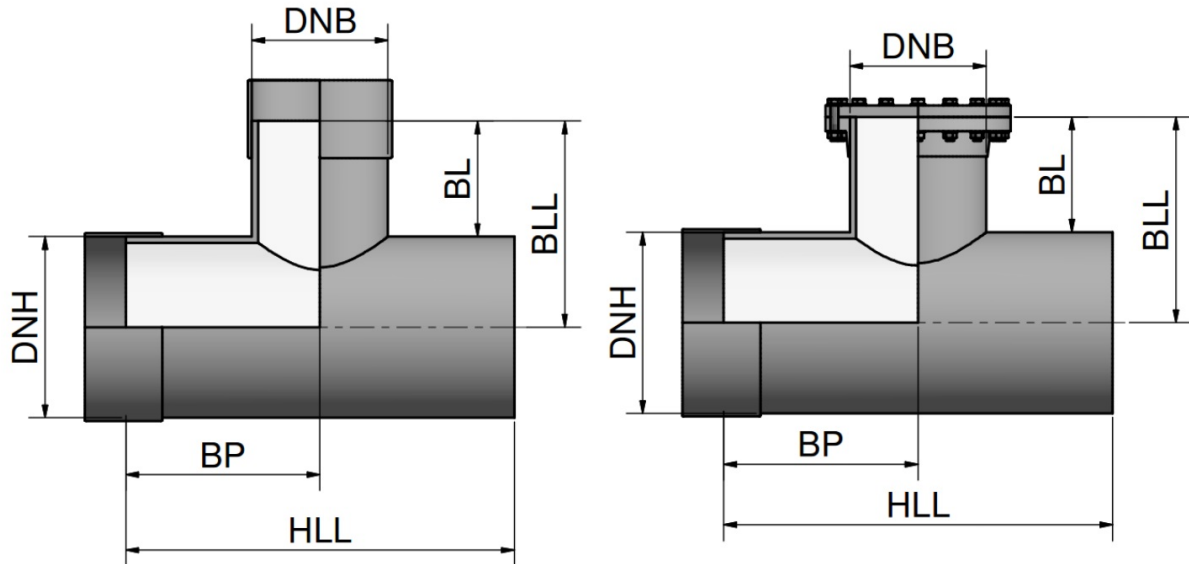

DN <sub>H</sub>	d <sub>eH</sub> [mm]	DN <sub>B</sub>	d <sub>eB</sub> [mm]	HLL [mm]	BL [mm]	BLL [mm]	BP [mm]
2200	2250	200	220	800	225	1350	400
		600	616	1200	275	1400	600
		960	960	1550	275	1400	775
		1535	1535	2200	375	1500	1100
		2200	2250	3000	375	1500	1500
2400	2400	200	220	800	250	1450	400
		600	616	1200	300	1500	600
		1000	1026	1650	300	1500	825
		1600	1638	2300	350	1550	1150
		2400	2400	3150	400	1600	1575
2453	2453	200	220	800	223	1450	400
		600	616	1200	273	1500	600
		1000	1026	1650	273	1500	825
		1600	1638	2300	373	1600	1150
		2453	2453	3200	373	1600	1600
2555	2555	200	220	850	222	1500	425
		650	650	1300	322	1600	650
		1100	1099	1800	322	1600	900
		1720	1720	2450	372	1650	1225
		2555	2555	3350	422	1700	1675

Table contains selected branch sizes. For our full portfolio, please visit [www.amiblu.com/amiblu-products](http://www.amiblu.com/amiblu-products).

Sizes can be adapted to meet transport requirements. For project-related dimensions, please contact Amiblu.

Amiblu Holding GmbH | Pischeldorfer Str. 128 | 9020 Klagenfurt | Austria | +43 463 482424 | [www.amiblu.com](http://www.amiblu.com) | [info@amiblu.com](mailto:info@amiblu.com)

© Amiblu Holding GmbH. Figures may slightly vary due to manufacturing tolerances. Amiblu does not accept any liability for errors, omissions, and subsequent changes to technical data.

# T-Piece Concentric PN 1

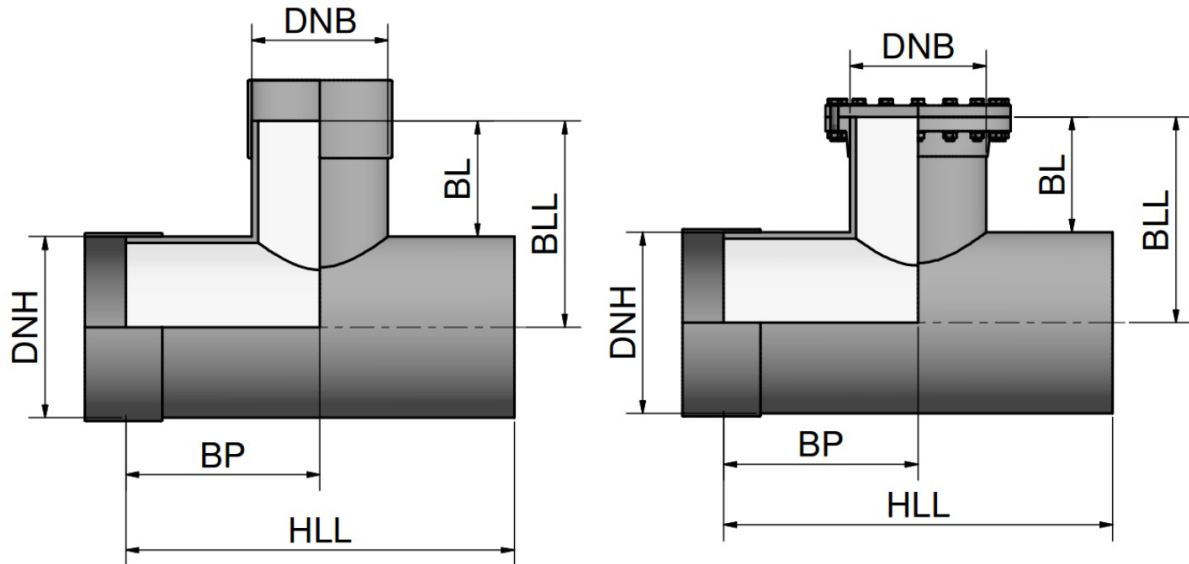

DN <sub>H</sub>	d <sub>eH</sub> [mm]	DN <sub>B</sub>	d <sub>eB</sub> [mm]	HLL [mm]	BL [mm]	BLL [mm]	BP [mm]
3000	2999	200	220	850	250	1750	425
		650	650	1300	300	1800	650
		1100	1099	1800	300	1800	900
		1800	1842	2550	350	1850	1275
		3000	2999	3850	450	1950	1925
3270	3270	200	220	850	215	1850	425
		650	650	1300	315	1950	650
		1200	1229	1900	315	1950	950
		1940	1937	2700	365	2000	1350
		3270	3270	4150	465	2100	2075
3600	3600	200	220	850	250	2050	425
		650	650	1300	300	2100	650
		1200	1229	1900	300	2100	950
		1940	1937	2700	350	2150	1350
		3270	3270	4150	450	2250	2075

Table contains selected branch sizes. For our full portfolio, please visit [www.amiblu.com/amiblu-products](http://www.amiblu.com/amiblu-products).  
 Sizes can be adapted to meet transport requirements. For project-related dimensions, please contact Amiblu.

Amiblu Holding GmbH | Pischeldorfer Str. 128 | 9020 Klagenfurt | Austria | +43 463 482424 | [www.amiblu.com](http://www.amiblu.com) | [info@amiblu.com](mailto:info@amiblu.com)

© Amiblu Holding GmbH. Figures may slightly vary due to manufacturing tolerances. Amiblu does not accept any liability for errors, omissions, and subsequent changes to technical data.

# T-Piece Eccentric PN 1

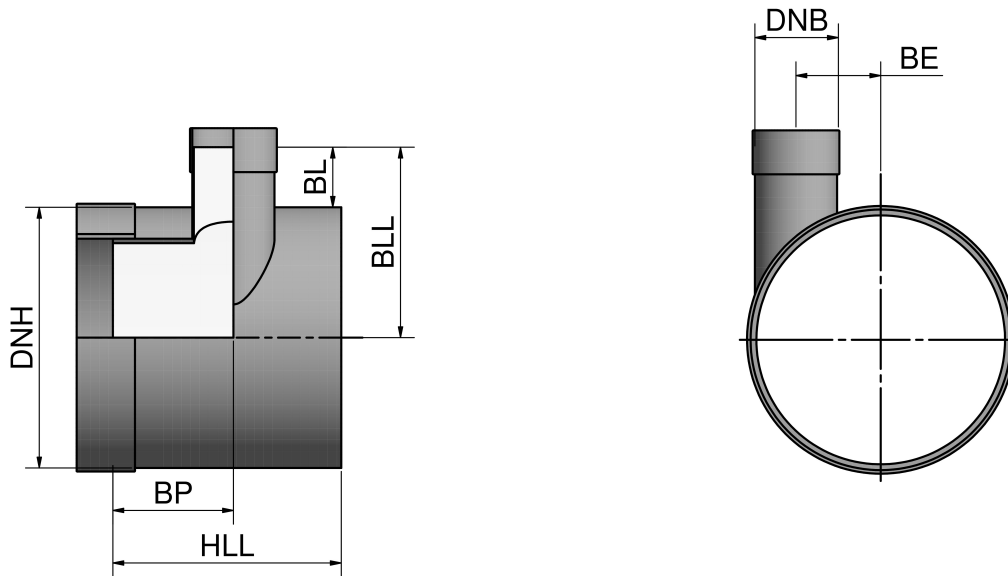

DN <sub>H</sub>	d <sub>eH</sub> [mm]	DN <sub>B</sub>	d <sub>eB</sub> [mm]	HLL [mm]	BL [mm]	BLL [mm]	BP [mm]	BE [mm]
250	272	200	220	650	214	350	325	26
300	324	200	220	750	238	400	375	52
		250	272	800	238	400	400	26
350	376	200	220	750	212	400	375	78
		250	272	800	212	400	400	52
		300	324	850	262	450	425	26
400	427	200	220	750	236	450	375	103
		250	272	800	236	450	400	77
		300	324	850	286	500	425	51
		350	376	900	286	500	450	25
450	478	200	220	750	211	450	375	129
		250	272	800	211	450	400	103
		300	324	850	261	500	425	77
		350	376	900	261	500	450	51
		400	427	950	261	500	475	25

Table contains selected branch sizes. For our full portfolio, please visit [www.amiblu.com/amiblu-products](http://www.amiblu.com/amiblu-products).  
 Sizes can be adapted to meet transport requirements. For project-related dimensions, please contact Amiblu.

Amiblu Holding GmbH | Pischeldorfer Str. 128 | 9020 Klagenfurt | Austria | +43 463 482424 | [www.amiblu.com](http://www.amiblu.com) | [info@amiblu.com](mailto:info@amiblu.com)

© Amiblu Holding GmbH. Figures may slightly vary due to manufacturing tolerances. Amiblu does not accept any liability for errors, omissions, and subsequent changes to technical data.

# T-Piece Eccentric PN 1

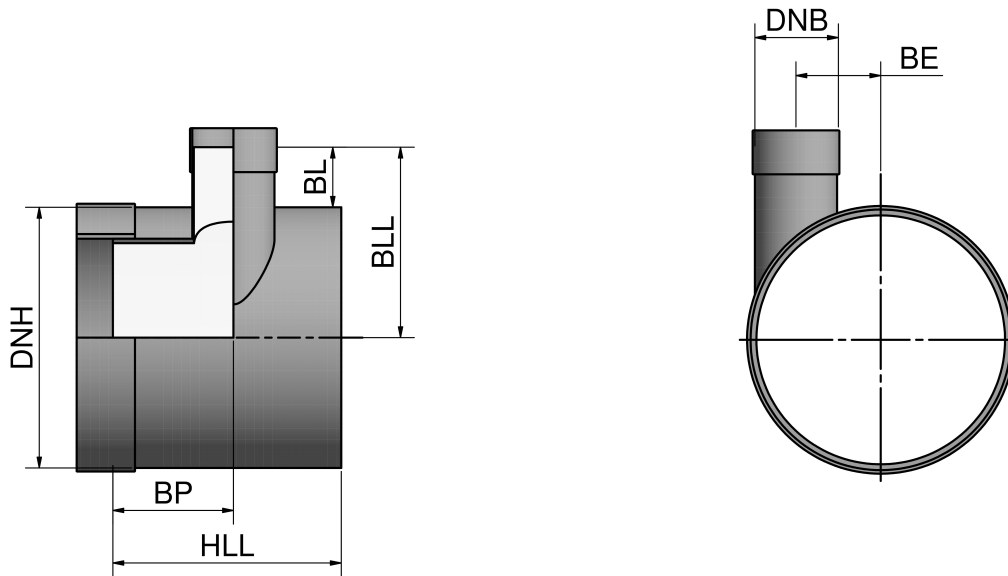

DN <sub>H</sub>	d <sub>eH</sub> [mm]	DN <sub>B</sub>	d <sub>eB</sub> [mm]	HLL [mm]	BL [mm]	BLL [mm]	BP [mm]	BE [mm]
500	530	200	220	750	235	500	375	155
		300	324	850	285	550	425	103
		350	376	900	285	550	450	77
		400	427	950	285	550	475	51
		450	478	1000	285	550	500	26
550	550	200	220	750	225	500	375	165
		300	324	850	275	550	425	113
		400	427	950	275	550	475	61
		450	478	1000	275	550	500	36
		500	530	1050	275	550	525	10
600	616	200	220	750	242	550	375	198
		300	324	900	292	600	450	146
		400	427	1000	292	600	500	94
		450	478	1050	292	600	525	69
		550	550	1100	292	600	550	33
650	650	200	220	750	225	550	375	215
		350	376	950	275	600	475	137
		450	478	1050	275	600	525	86
		500	530	1100	275	600	550	60
		600	616	1150	275	600	575	17

Table contains selected branch sizes. For our full portfolio, please visit [www.amiblu.com/amiblu-products](http://www.amiblu.com/amiblu-products).  
 Sizes can be adapted to meet transport requirements. For project-related dimensions, please contact Amiblu.

Amiblu Holding GmbH | Pischeldorfer Str. 128 | 9020 Klagenfurt | Austria | +43 463 482424 | [www.amiblu.com](http://www.amiblu.com) | [info@amiblu.com](mailto:info@amiblu.com)

© Amiblu Holding GmbH. Figures may slightly vary due to manufacturing tolerances. Amiblu does not accept any liability for errors, omissions, and subsequent changes to technical data.

# T-Piece Eccentric PN 1

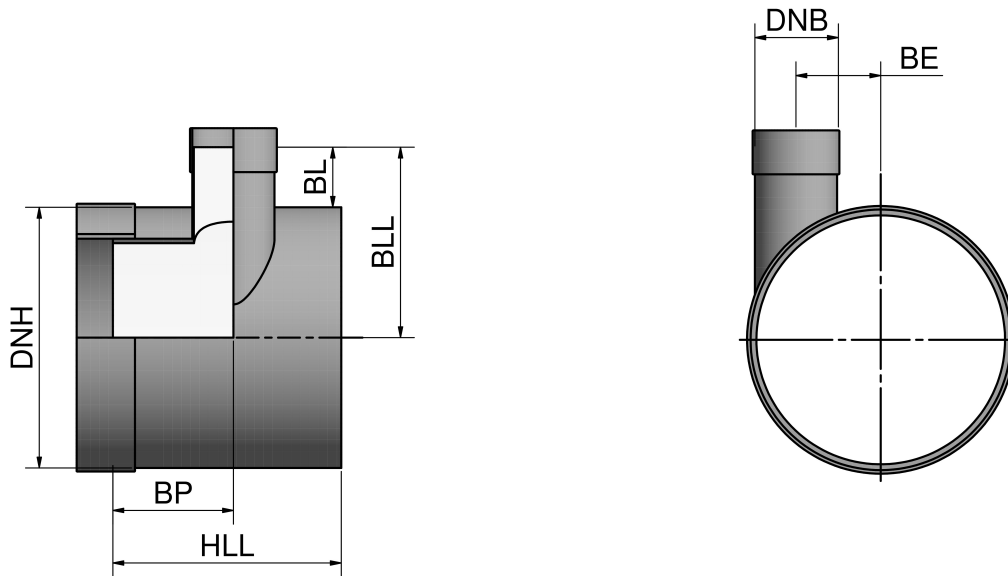

DN <sub>H</sub>	d <sub>eH</sub> [mm]	DN <sub>B</sub>	d <sub>eB</sub> [mm]	HLL [mm]	BL [mm]	BLL [mm]	BP [mm]	BE [mm]
700	718	200	220	750	191	550	375	249
		350	376	950	291	650	475	171
		450	478	1050	291	650	525	120
		550	550	1100	291	650	550	84
		650	650	1200	291	650	600	34
750	752	200	220	750	224	600	375	266
		350	376	950	274	650	475	188
		500	530	1100	274	650	550	111
		600	616	1150	274	650	575	68
		700	718	1300	274	650	650	17
800	820	200	220	750	190	600	375	300
		350	376	950	290	700	475	222
		500	530	1100	290	700	550	145
		600	616	1150	290	700	575	102
		750	752	1300	290	700	650	34
860	860	200	220	750	170	600	375	320
		400	427	1000	270	700	500	216
		550	550	1100	270	700	550	155
		650	650	1200	320	750	600	105
		800	820	1400	320	750	700	20

Table contains selected branch sizes. For our full portfolio, please visit [www.amiblu.com/amiblu-products](http://www.amiblu.com/amiblu-products).  
 Sizes can be adapted to meet transport requirements. For project-related dimensions, please contact Amiblu.

Amiblu Holding GmbH | Pischeldorfer Str. 128 | 9020 Klagenfurt | Austria | +43 463 482424 | [www.amiblu.com](http://www.amiblu.com) | [info@amiblu.com](mailto:info@amiblu.com)

© Amiblu Holding GmbH. Figures may slightly vary due to manufacturing tolerances. Amiblu does not accept any liability for errors, omissions, and subsequent changes to technical data.

# T-Piece Eccentric PN 1

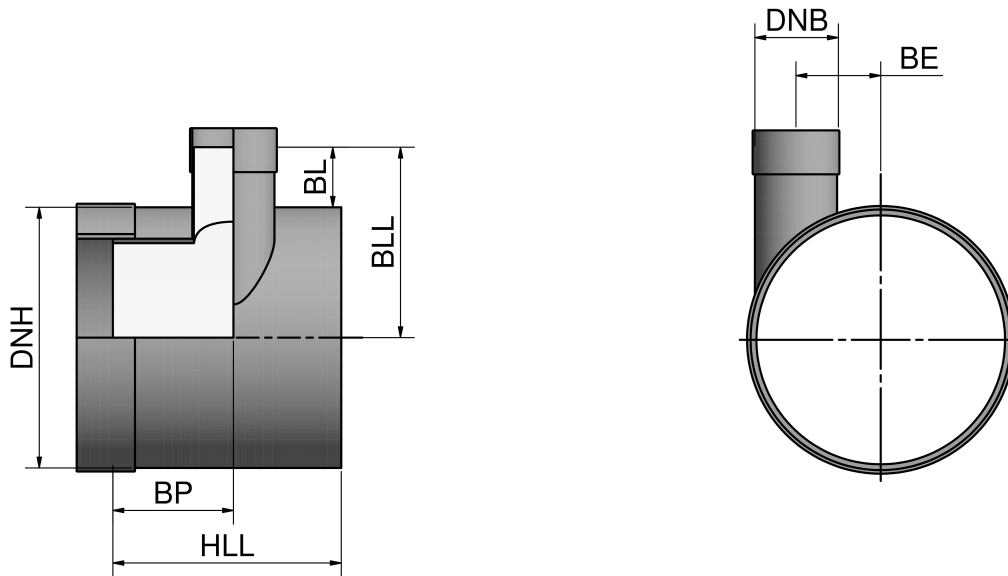

DN <sub>H</sub>	d <sub>eH</sub> [mm]	DN <sub>B</sub>	d <sub>eB</sub> [mm]	HLL [mm]	BL [mm]	BLL [mm]	BP [mm]	BE [mm]
900	924	200	220	750	188	650	375	352
		400	427	1000	288	750	500	248
		550	550	1100	288	750	550	187
		700	718	1300	288	750	650	103
		860	860	1450	288	750	725	32
960	960	200	220	750	170	650	375	370
		400	427	1000	270	750	500	266
		600	616	1150	270	750	575	172
		750	752	1300	320	800	650	104
		900	924	1500	320	800	750	18
1000	1026	200	220	750	137	650	375	403
		400	427	1000	287	800	500	299
		600	616	1150	287	800	575	205
		750	752	1300	287	800	650	137
		960	960	1550	287	800	775	33
1100	1099	200	220	750	100	650	375	439
		450	478	1050	250	800	525	310
		650	650	1200	300	850	600	224
		800	820	1400	300	850	700	139
		1000	1026	1600	300	850	800	36

Table contains selected branch sizes. For our full portfolio, please visit [www.amiblu.com/amiblu-products](http://www.amiblu.com/amiblu-products).  
 Sizes can be adapted to meet transport requirements. For project-related dimensions, please contact Amiblu.

Amiblu Holding GmbH | Pischeldorfer Str. 128 | 9020 Klagenfurt | Austria | +43 463 482424 | [www.amiblu.com](http://www.amiblu.com) | [info@amiblu.com](mailto:info@amiblu.com)

© Amiblu Holding GmbH. Figures may slightly vary due to manufacturing tolerances. Amiblu does not accept any liability for errors, omissions, and subsequent changes to technical data.

# T-Piece Eccentric PN 1

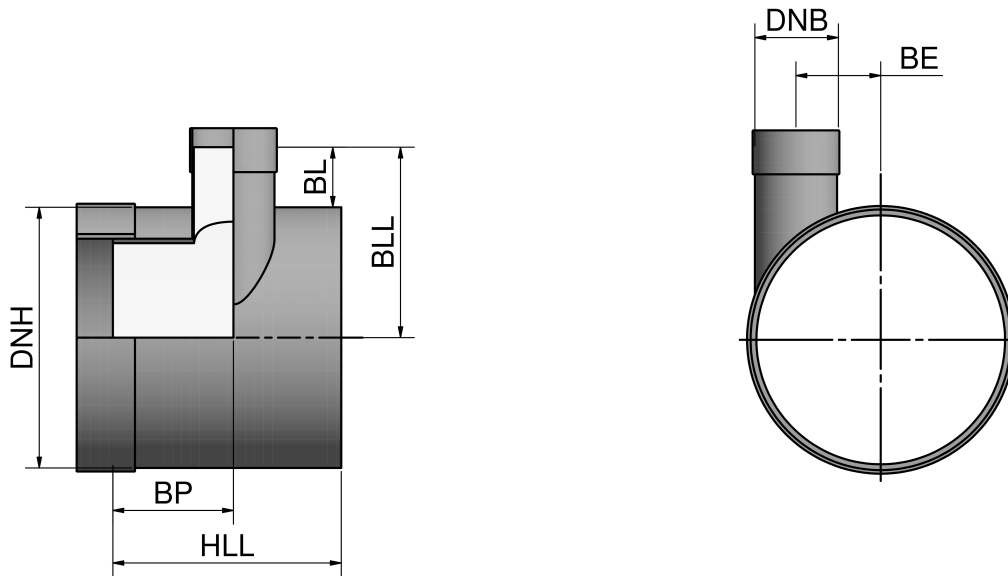

DN <sub>H</sub>	d <sub>eH</sub> [mm]	DN <sub>B</sub>	d <sub>eB</sub> [mm]	HLL [mm]	BL [mm]	BLL [mm]	BP [mm]	BE [mm]
1200	1229	200	220	750	85	700	375	504
		450	478	1050	285	900	525	375
		650	650	1200	285	900	600	289
		860	860	1450	285	900	725	184
		1100	1099	1700	335	950	850	65
1280	1280	200	220	750	60	700	375	530
		450	478	1050	260	900	525	401
		700	718	1300	310	950	650	281
		900	924	1500	310	950	750	178
		1200	1229	1850	310	950	925	25
1400	1434	200	220	750	33	750	375	607
		450	478	1050	233	950	525	478
		700	718	1300	283	1000	650	358
		900	924	1500	283	1000	750	255
		1280	1280	1900	333	1050	950	77
1500	1499	200	220	800	0	750	400	639
		500	530	1150	250	1000	575	484
		750	752	1350	300	1050	675	373
		960	960	1550	300	1050	775	269
		1400	1434	2100	300	1050	1050	32

Table contains selected branch sizes. For our full portfolio, please visit [www.amiblu.com/amiblu-products](http://www.amiblu.com/amiblu-products).  
 Sizes can be adapted to meet transport requirements. For project-related dimensions, please contact Amiblu.

Amiblu Holding GmbH | Pischeldorfer Str. 128 | 9020 Klagenfurt | Austria | +43 463 482424 | [www.amiblu.com](http://www.amiblu.com) | [info@amiblu.com](mailto:info@amiblu.com)

© Amiblu Holding GmbH. Figures may slightly vary due to manufacturing tolerances. Amiblu does not accept any liability for errors, omissions, and subsequent changes to technical data.



# T-Piece Eccentric PN 1

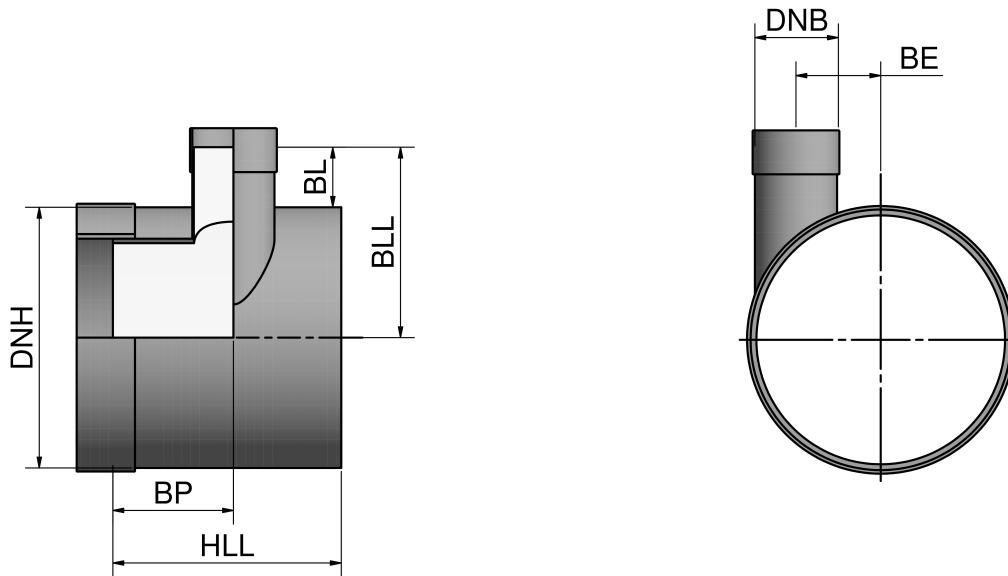

DN <sub>H</sub>	d <sub>eH</sub> [mm]	DN <sub>B</sub>	d <sub>eB</sub> [mm]	HLL [mm]	BL [mm]	BLL [mm]	BP [mm]	BE [mm]
1535	1535	200	220	800	-17	750	400	657
		500	530	1150	232	1000	575	502
		750	752	1350	282	1050	675	391
		1000	1026	1650	282	1050	825	254
		1500	1499	2200	332	1100	1100	18
1600	1638	200	220	800	-19	800	400	709
		500	530	1150	231	1050	575	554
		800	820	1450	281	1100	725	409
		1100	1099	1750	331	1150	875	269
		1535	1535	2200	331	1150	1100	51
1720	1720	200	220	800	-60	800	400	750
		500	530	1150	190	1050	575	595
		800	820	1450	290	1150	725	450
		1100	1099	1750	290	1150	875	310
		1600	1638	2300	340	1200	1150	41
1800	1842	200	220	800	-71	850	400	811
		550	550	1150	179	1100	575	646
		860	860	1450	279	1200	725	491
		1200	1229	1850	329	1250	925	306
		1720	1720	2400	329	1250	1200	61

Table contains selected branch sizes. For our full portfolio, please visit [www.amiblu.com/amiblu-products](http://www.amiblu.com/amiblu-products).  
 Sizes can be adapted to meet transport requirements. For project-related dimensions, please contact Amiblu.

Amiblu Holding GmbH | Pischeldorfer Str. 128 | 9020 Klagenfurt | Austria | +43 463 482424 | [www.amiblu.com](http://www.amiblu.com) | [info@amiblu.com](mailto:info@amiblu.com)

© Amiblu Holding GmbH. Figures may slightly vary due to manufacturing tolerances. Amiblu does not accept any liability for errors, omissions, and subsequent changes to technical data.

# T-Piece Eccentric PN 1

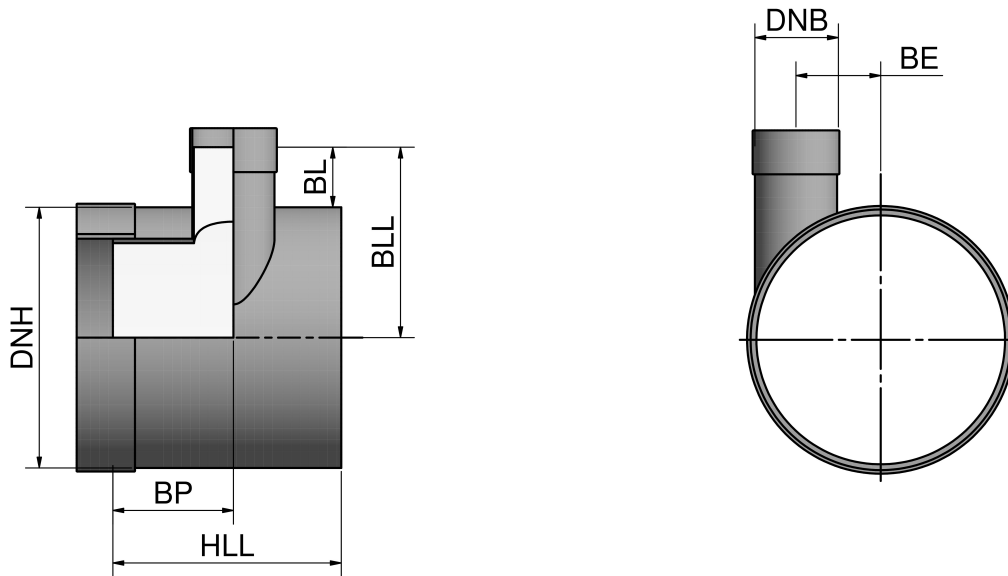

DN <sub>H</sub>	d <sub>eH</sub> [mm]	DN <sub>B</sub>	d <sub>eB</sub> [mm]	HLL [mm]	BL [mm]	BLL [mm]	BP [mm]	BE [mm]
1940	1937	200	220	800	-118	850	400	858
		550	550	1150	181	1150	575	693
		860	860	1450	281	1250	725	538
		1280	1280	1950	331	1300	975	328
		1800	1842	2550	381	1350	1275	47
2000	2047	200	220	800	-173	850	400	913
		550	550	1150	176	1200	575	748
		900	924	1550	276	1300	775	561
		1400	1434	2100	326	1350	1050	306
		1940	1937	2650	376	1400	1325	55
2160	2160	200	220	800	-180	900	400	970
		550	550	1150	120	1200	575	805
		900	924	1550	270	1350	775	618
		1400	1434	2100	320	1400	1050	363
		2000	2047	2750	370	1450	1375	56
2200	2250	200	220	800	-225	900	400	1015
		600	616	1200	175	1300	600	817
		960	960	1550	275	1400	775	645
		1500	1499	2200	375	1500	1100	375
		2160	2160	2900	375	1500	1450	45

Table contains selected branch sizes. For our full portfolio, please visit [www.amiblu.com/amiblu-products](http://www.amiblu.com/amiblu-products).  
 Sizes can be adapted to meet transport requirements. For project-related dimensions, please contact Amiblu.

Amiblu Holding GmbH | Pischeldorfer Str. 128 | 9020 Klagenfurt | Austria | +43 463 482424 | [www.amiblu.com](http://www.amiblu.com) | [info@amiblu.com](mailto:info@amiblu.com)

© Amiblu Holding GmbH. Figures may slightly vary due to manufacturing tolerances. Amiblu does not accept any liability for errors, omissions, and subsequent changes to technical data.

# T-Piece Eccentric PN 1

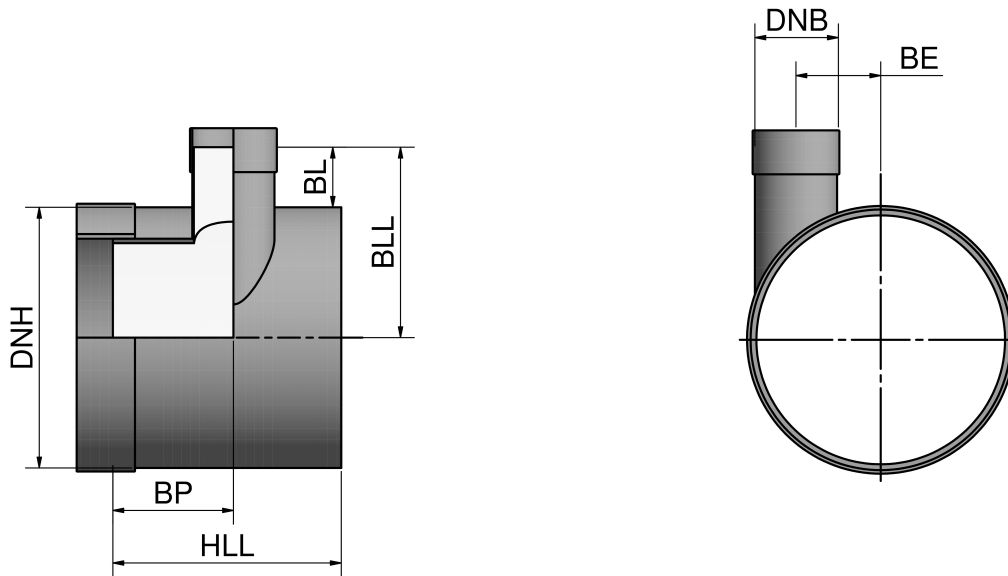

DN <sub>H</sub>	d <sub>eH</sub> [mm]	DN <sub>B</sub>	d <sub>eB</sub> [mm]	HLL [mm]	BL [mm]	BLL [mm]	BP [mm]	BE [mm]
2400	2400	200	220	800	-250	950	400	1090
		600	616	1200	150	1350	600	892
		960	960	1550	250	1450	775	720
		1535	1535	2200	350	1550	1100	432
		2200	2250	3000	400	1600	1500	75
2453	2453	200	220	800	-276	950	400	1116
		600	616	1200	123	1350	600	918
		1000	1026	1650	273	1500	825	713
		1600	1638	2300	373	1600	1150	407
		2400	2400	3150	373	1600	1575	26
2555	2555	200	220	850	-327	950	425	1167
		600	616	1250	122	1400	625	969
		1000	1026	1650	272	1550	825	764
		1600	1638	2350	372	1650	1175	458
		2453	2453	3250	372	1650	1625	51
3000	2999	200	220	850	-499	1000	425	1389
		650	650	1300	50	1550	650	1174
		1100	1099	1800	250	1750	900	950
		1720	1720	2450	350	1850	1225	639
		2555	2555	3350	400	1900	1675	222

Table contains selected branch sizes. For our full portfolio, please visit [www.amiblu.com/amiblu-products](http://www.amiblu.com/amiblu-products).  
 Sizes can be adapted to meet transport requirements. For project-related dimensions, please contact Amiblu.

Amiblu Holding GmbH | Pischeldorfer Str. 128 | 9020 Klagenfurt | Austria | +43 463 482424 | [www.amiblu.com](http://www.amiblu.com) | [info@amiblu.com](mailto:info@amiblu.com)

© Amiblu Holding GmbH. Figures may slightly vary due to manufacturing tolerances. Amiblu does not accept any liability for errors, omissions, and subsequent changes to technical data.

# T-Piece Eccentric PN 1

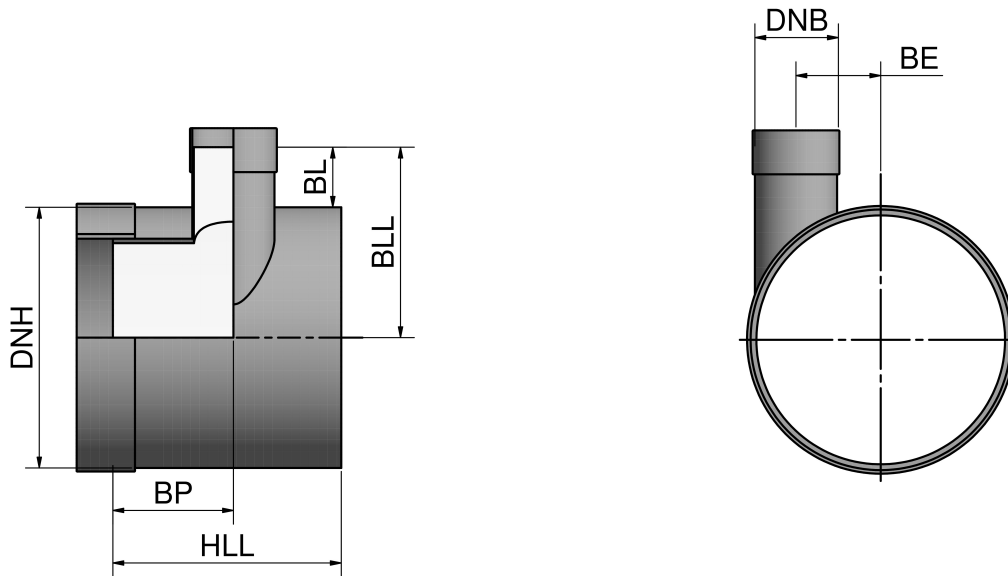

DN <sub>H</sub>	d <sub>eH</sub> [mm]	DN <sub>B</sub>	d <sub>eB</sub> [mm]	HLL [mm]	BL [mm]	BLL [mm]	BP [mm]	BE [mm]
3270	3270	200	220	850	-585	1050	425	1525
		650	650	1300	-35	1600	650	1310
		1100	1099	1800	215	1850	900	1085
		1800	1842	2550	365	2000	1275	714
		3000	2999	3850	415	2050	1925	135
3600	3600	200	220	850	-700	1100	425	1690
		650	650	1300	-100	1700	650	1475
		1200	1229	1900	200	2000	950	1185
		1940	1937	2700	350	2150	1350	831
		3270	3270	4150	450	2250	2075	165

Table contains selected branch sizes. For our full portfolio, please visit [www.amiblu.com/amiblu-products](http://www.amiblu.com/amiblu-products).  
 Sizes can be adapted to meet transport requirements. For project-related dimensions, please contact Amiblu.

Amiblu Holding GmbH | Pischeldorfer Str. 128 | 9020 Klagenfurt | Austria | +43 463 482424 | [www.amiblu.com](http://www.amiblu.com) | [info@amiblu.com](mailto:info@amiblu.com)

© Amiblu Holding GmbH. Figures may slightly vary due to manufacturing tolerances. Amiblu does not accept any liability for errors, omissions, and subsequent changes to technical data.

# Reducer PN 1

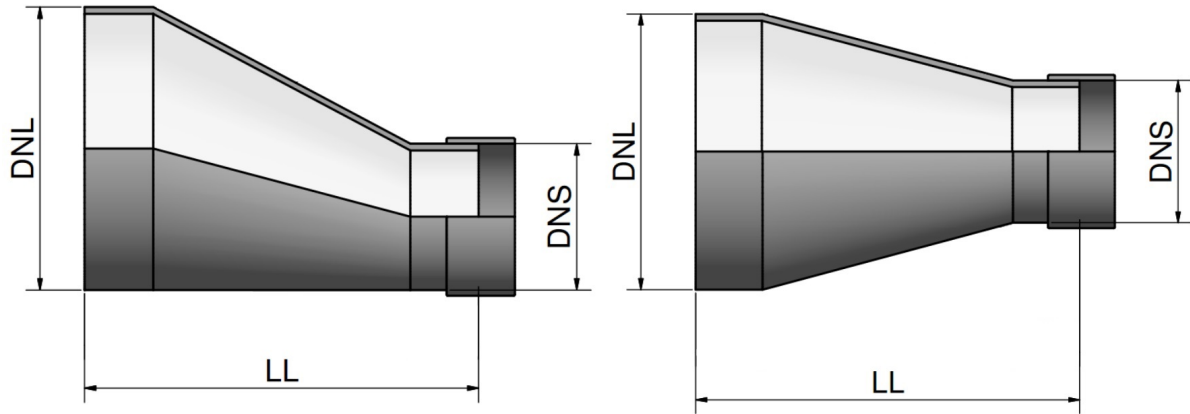

DN <sub>L</sub>	d <sub>eL</sub> [mm]	DN <sub>S</sub>	d <sub>eS</sub> [mm]	LL [mm]	DN <sub>S</sub>	d <sub>eS</sub> [mm]	LL [mm]	DN <sub>S</sub>	d <sub>eS</sub> [mm]	LL [mm]	DN <sub>S</sub>	d <sub>eS</sub> [mm]	LL [mm]
250	272	200	220	725	-	-	-	-	-	-	-	-	-
300	324	250	272	925	200	220	1050	-	-	-	-	-	-
350	376	300	324	925	250	272	1050	200	220	1175	-	-	-
400	427	350	376	925	300	324	1050	250	272	1175	200	220	1300
450	478	400	427	925	350	376	1050	300	324	1175	250	272	1300
500	530	450	478	925	400	427	1050	350	376	1175	300	324	1300
550	550	500	530	925	450	478	1050	400	427	1175	350	376	1300
600	616	550	550	925	500	530	1050	450	478	1175	400	427	1300
650	650	600	616	925	550	550	1050	500	530	1175	450	478	1300
700	718	650	650	925	600	616	1050	550	550	1175	500	530	1300
750	752	700	718	925	650	650	1050	600	616	1175	550	550	1300
800	820	750	752	925	700	718	1050	650	650	1175	600	616	1300
860	860	800	820	950	750	752	1075	700	718	1200	650	650	1325
900	924	860	860	900	800	820	1050	750	752	1175	700	718	1300
960	960	900	924	950	860	860	1050	800	820	1200	750	752	1325
1000	1026	960	960	900	900	924	1050	860	860	1150	800	820	1300
1100	1099	1000	1026	1050	960	960	1150	900	924	1300	860	860	1400
1200	1229	1100	1099	1050	1000	1026	1300	960	960	1400	900	924	1550
1280	1280	1200	1229	1000	1100	1099	1250	1000	1026	1500	960	960	1600
1400	1434	1280	1280	1300	1200	1229	1500	1100	1099	1750	1000	1026	2000

Sizes can be adapted to meet transport requirements. For project-related dimensions, please contact Amiblu.

Amiblu Holding GmbH | Pischeldorfer Str. 128 | 9020 Klagenfurt | Austria | +43 463 482424 | www.amiblu.com | info@amiblu.com

© Amiblu Holding GmbH. Figures may slightly vary due to manufacturing tolerances. Amiblu does not accept any liability for errors, omissions, and subsequent changes to technical data.

# Reducer PN 1

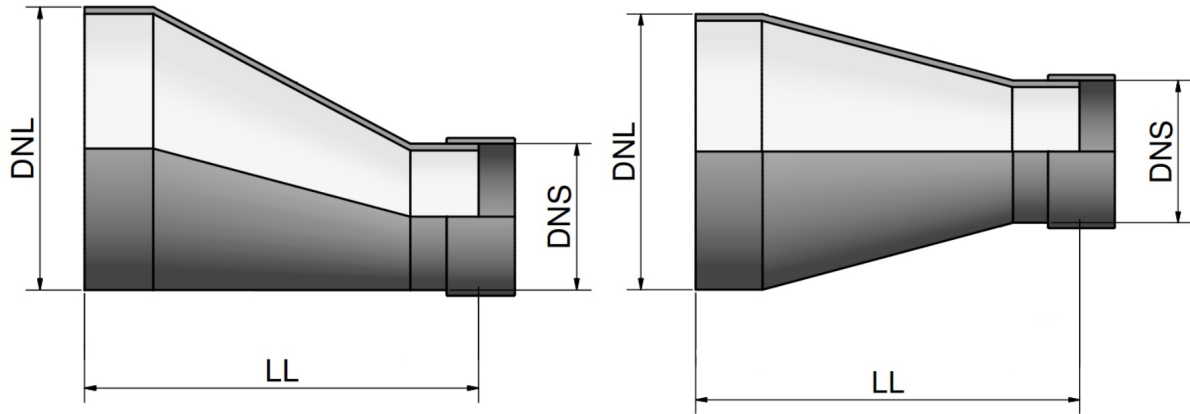

DN <sub>L</sub>	d <sub>eL</sub> [mm]	DN <sub>S</sub>	d <sub>eS</sub> [mm]	LL [mm]	DN <sub>S</sub>	d <sub>eS</sub> [mm]	LL [mm]	DN <sub>S</sub>	d <sub>eS</sub> [mm]	LL [mm]	DN <sub>S</sub>	d <sub>eS</sub> [mm]	LL [mm]
1500	1499	1400	1434	1250	1280	1280	1550	1200	1229	1750	-	-	-
1535	1535	1400	1434	1338	1280	1280	1638	1200	1229	1838	-	-	-
1600	1638	1535	1535	1163	1500	1499	1250	1400	1434	1500	1280	1280	1800
1720	1720	1600	1638	1300	1535	1535	1463	1500	1499	1550	1400	1434	1800
1800	1842	1720	1720	1200	1600	1638	1500	1535	1535	1663	1500	1499	1750
1940	1937	1800	1842	1350	1720	1720	1550	1600	1638	1850	-	-	-
2000	2047	1940	1937	1150	1800	1842	1500	1720	1720	1700	1600	1638	2000
2160	2160	2000	2047	1400	1940	1937	1550	1800	1842	1900	-	-	-
2200	2250	2160	2160	1100	2000	2047	1500	1940	1937	1650	1800	1842	2000
2400	2400	2200	2250	1700	2160	2160	1800	2000	2047	2200	-	-	-
2453	2453	2200	2250	1833	2160	2160	1933	-	-	-	-	-	-
2555	2555	2453	2453	1455	2400	2400	1588	2200	2250	2088	2160	2160	2188
3000	2999	2555	2555	2313	2453	2453	2568	-	-	-	-	-	-
3270	3270	3000	2999	1875	2555	2555	2988	-	-	-	-	-	-
3600	3600	3270	3270	2025	3000	2999	2700	-	-	-	-	-	-

Sizes can be adapted to meet transport requirements. For project-related dimensions, please contact Amiblu.

Amiblu Holding GmbH | Pischeldorfer Str. 128 | 9020 Klagenfurt | Austria | +43 463 482424 | www.amiblu.com | info@amiblu.com

© Amiblu Holding GmbH. Figures may slightly vary due to manufacturing tolerances. Amiblu does not accept any liability for errors, omissions, and subsequent changes to technical data.

# y-Piece PN 1, 45°

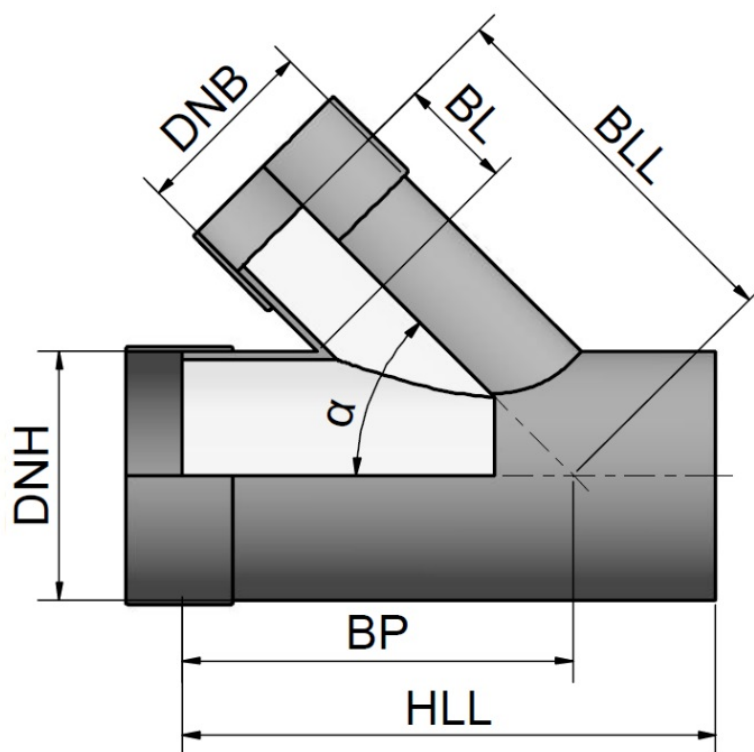

DN <sub>H</sub>	d <sub>eH</sub> [mm]	DN <sub>B</sub>	d <sub>eB</sub> [mm]	HLL [mm]	BL [mm]	BLL [mm]	BP [mm]	α [°]
200	220	200	220	850	284	550	550	45
250	272	200	220	850	298	600	600	45
		250	272	950	272	600	650	45
300	324	200	220	900	261	600	650	45
		250	272	1000	285	650	700	45
		300	324	1100	309	700	750	45
350	376	200	220	900	274	650	650	45
		250	272	1000	298	700	700	45
		300	324	1100	322	750	750	45
		350	376	1150	346	800	800	45
400	427	200	220	900	288	700	700	45
		250	272	1000	262	700	750	45
		300	324	1100	336	800	800	45
		350	376	1150	310	800	800	45
		400	427	1250	335	850	850	45

Table contains selected branch sizes. For our full portfolio, please visit [www.amiblu.com/amiblu-products](http://www.amiblu.com/amiblu-products).  
 Sizes can be adapted to meet transport requirements. For project-related dimensions, please contact Amiblu.

Amiblu Holding GmbH | Pischeldorfer Str. 128 | 9020 Klagenfurt | Austria | +43 463 482424 | [www.amiblu.com](http://www.amiblu.com) | [info@amiblu.com](mailto:info@amiblu.com)

© Amiblu Holding GmbH. Figures may slightly vary due to manufacturing tolerances. Amiblu does not accept any liability for errors, omissions, and subsequent changes to technical data.

# y-Piece PN 1, 45°

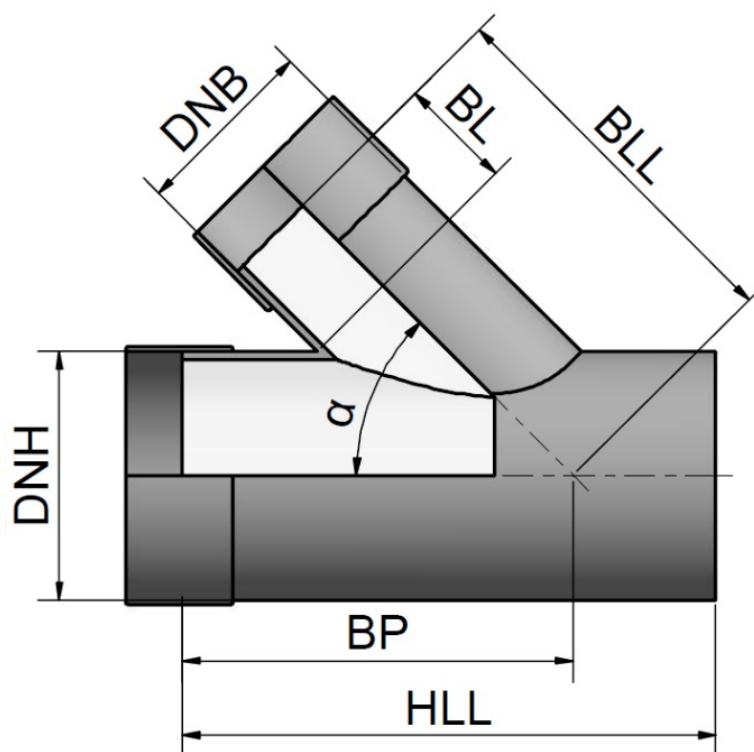

DN <sub>H</sub>	d <sub>eH</sub> [mm]	DN <sub>B</sub>	d <sub>eB</sub> [mm]	HLL [mm]	BL [mm]	BLL [mm]	BP [mm]	α [°]
450	478	200	220	900	302	750	700	45
		300	324	1100	350	850	800	45
		350	376	1150	324	850	850	45
		400	427	1250	349	900	900	45
		450	478	1300	323	900	900	45
500	530	200	220	900	265	750	750	45
		300	324	1100	313	850	850	45
		400	427	1250	312	900	900	45
		450	478	1300	336	950	950	45
		500	530	1400	310	950	1000	45
550	550	200	220	900	301	800	750	45
		300	324	1100	349	900	850	45
		400	427	1250	348	950	900	45
		450	478	1300	322	950	950	45
		550	550	1400	336	1000	1000	45
600	616	200	220	950	304	850	800	45
		350	376	1200	326	950	950	45
		450	478	1350	325	1000	1000	45
		500	530	1400	349	1050	1050	45
		600	616	1500	356	1100	1100	45

Table contains selected branch sizes. For our full portfolio, please visit [www.amiblu.com/amiblu-products](http://www.amiblu.com/amiblu-products).  
 Sizes can be adapted to meet transport requirements. For project-related dimensions, please contact Amiblu.

Amiblu Holding GmbH | Pischeldorfer Str. 128 | 9020 Klagenfurt | Austria | +43 463 482424 | [www.amiblu.com](http://www.amiblu.com) | [info@amiblu.com](mailto:info@amiblu.com)

© Amiblu Holding GmbH. Figures may slightly vary due to manufacturing tolerances. Amiblu does not accept any liability for errors, omissions, and subsequent changes to technical data.



# y-Piece PN 1, 45°

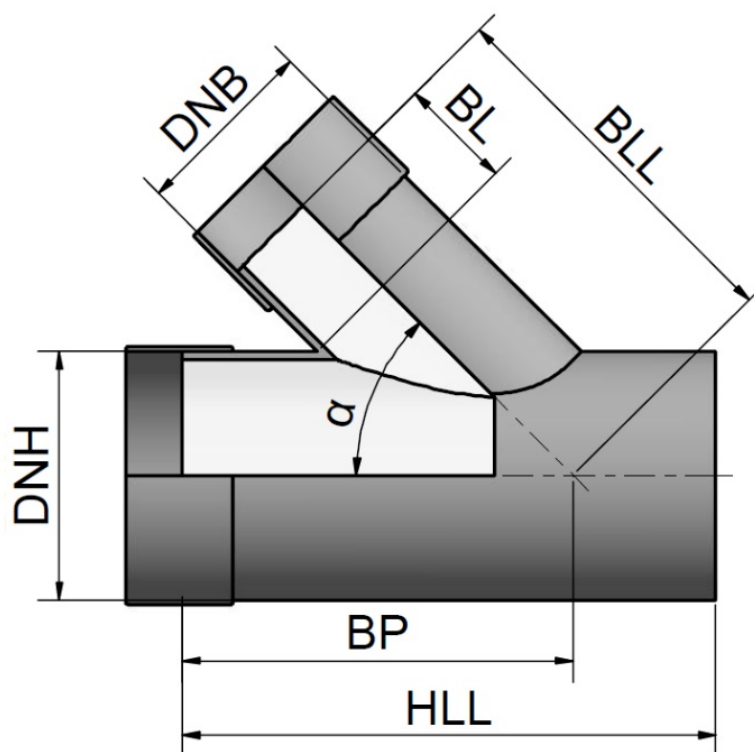

DN <sub>H</sub>	d <sub>eH</sub> [mm]	DN <sub>B</sub>	d <sub>eB</sub> [mm]	HLL [mm]	BL [mm]	BLL [mm]	BP [mm]	α [°]
650	650	200	220	950	280	850	800	45
		350	376	1200	302	950	950	45
		450	478	1350	301	1000	1000	45
		550	550	1450	315	1050	1050	45
		650	650	1600	365	1150	1150	45
700	718	200	220	950	282	900	850	45
		350	376	1200	304	1000	1000	45
		500	530	1400	327	1100	1100	45
		600	616	1500	334	1150	1150	45
		700	718	1700	333	1200	1250	45
750	752	200	220	950	308	950	900	45
		350	376	1200	330	1050	1000	45
		500	530	1400	303	1100	1100	45
		600	616	1500	360	1200	1150	45
		750	752	1750	342	1250	1300	45
800	820	200	220	950	260	950	900	45
		400	427	1250	307	1100	1050	45
		550	550	1450	345	1200	1150	45
		650	650	1600	345	1250	1250	45
		800	820	1850	360	1350	1350	45

Table contains selected branch sizes. For our full portfolio, please visit [www.amiblu.com/amiblu-products](http://www.amiblu.com/amiblu-products).  
 Sizes can be adapted to meet transport requirements. For project-related dimensions, please contact Amiblu.

Amiblu Holding GmbH | Pischeldorfer Str. 128 | 9020 Klagenfurt | Austria | +43 463 482424 | [www.amiblu.com](http://www.amiblu.com) | [info@amiblu.com](mailto:info@amiblu.com)

© Amiblu Holding GmbH. Figures may slightly vary due to manufacturing tolerances. Amiblu does not accept any liability for errors, omissions, and subsequent changes to technical data.

# y-Piece PN 1, 45°

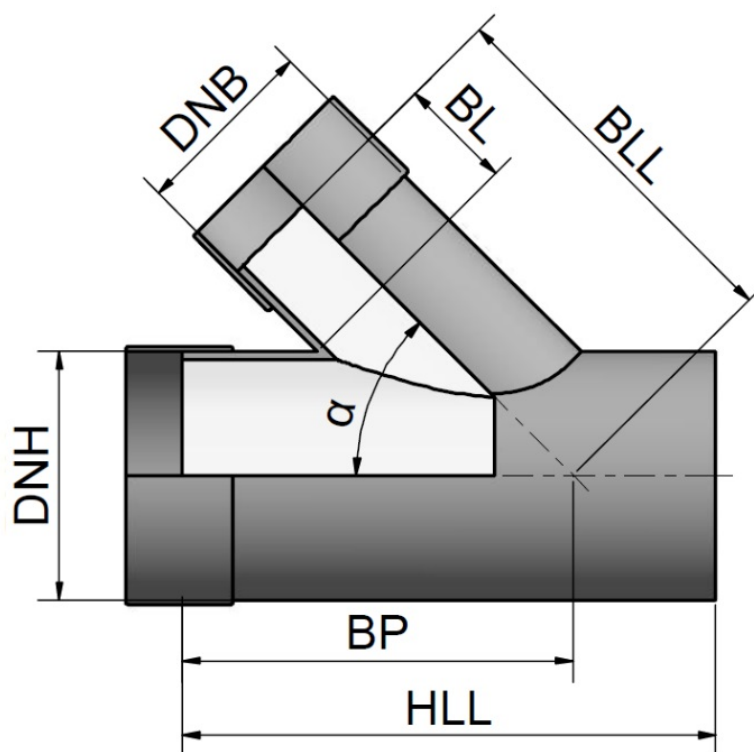

DN <sub>H</sub>	d <sub>eH</sub> [mm]	DN <sub>B</sub>	d <sub>eB</sub> [mm]	HLL [mm]	BL [mm]	BLL [mm]	BP [mm]	α [°]
860	860	200	220	950	282	1000	950	45
		400	427	1250	328	1150	1100	45
		550	550	1450	317	1200	1200	45
		700	718	1700	333	1300	1300	45
		860	860	1900	362	1400	1400	45
900	924	200	220	950	287	1050	950	45
		400	427	1250	333	1200	1100	45
		600	616	1500	339	1300	1250	45
		750	752	1750	371	1400	1350	45
		900	924	2000	335	1450	1500	45
960	960	200	220	950	261	1050	1000	45
		400	427	1250	308	1200	1150	45
		600	616	1500	363	1350	1250	45
		750	752	1750	345	1400	1400	45
		960	960	2050	341	1500	1550	45
1000	1026	200	220	950	265	1100	1000	45
		450	478	1350	336	1300	1200	45
		650	650	1600	350	1400	1350	45
		800	820	1850	365	1500	1450	45
		1000	1026	2100	362	1600	1600	45

Table contains selected branch sizes. For our full portfolio, please visit [www.amiblu.com/amiblu-products](http://www.amiblu.com/amiblu-products).  
 Sizes can be adapted to meet transport requirements. For project-related dimensions, please contact Amiblu.

Amiblu Holding GmbH | Pischeldorfer Str. 128 | 9020 Klagenfurt | Austria | +43 463 482424 | [www.amiblu.com](http://www.amiblu.com) | [info@amiblu.com](mailto:info@amiblu.com)

© Amiblu Holding GmbH. Figures may slightly vary due to manufacturing tolerances. Amiblu does not accept any liability for errors, omissions, and subsequent changes to technical data.

# y-Piece PN 1, 45°

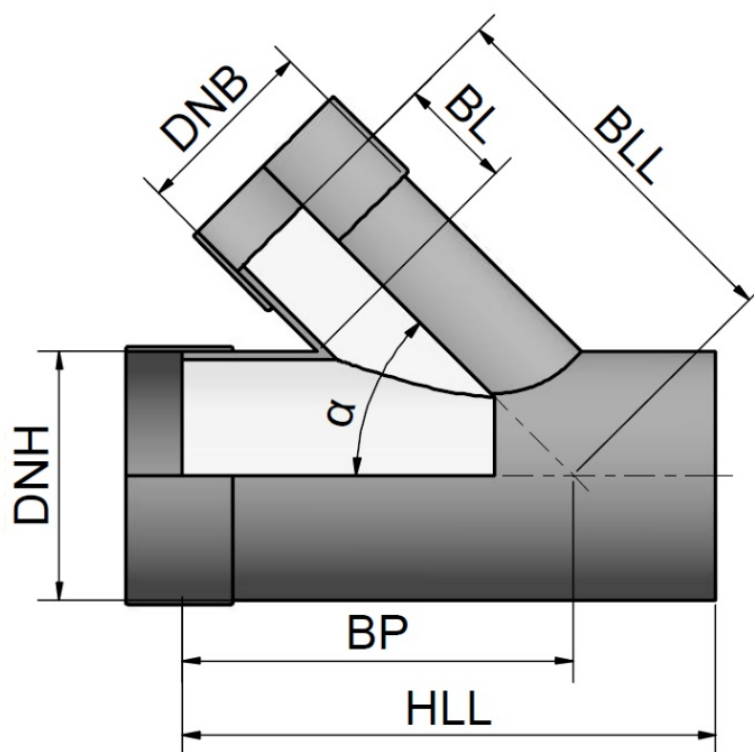

DN <sub>H</sub>	d <sub>eH</sub> [mm]	DN <sub>B</sub>	d <sub>eB</sub> [mm]	HLL [mm]	BL [mm]	BLL [mm]	BP [mm]	α [°]
1100	1099	200	220	950	263	1150	1050	45
		450	478	1350	334	1350	1250	45
		650	650	1600	348	1450	1350	45
		860	860	1900	343	1550	1500	45
		1100	1099	2250	373	1700	1700	45
1200	1229	200	220	950	271	1250	1100	45
		450	478	1350	342	1450	1300	45
		700	718	1700	372	1600	1500	45
		900	924	2000	369	1700	1650	45
		1200	1229	2450	367	1850	1850	45
1280	1280	200	220	950	285	1300	1150	45
		450	478	1350	306	1450	1350	45
		700	718	1700	336	1600	1500	45
		900	924	2000	333	1700	1650	45
		1280	1280	2500	355	1900	1900	45
1400	1434	200	220	950	276	1400	1200	45
		500	530	1400	321	1600	1450	45
		750	752	1750	360	1750	1600	45
		960	960	2050	356	1850	1750	45
		1400	1434	2750	369	2100	2100	45

Table contains selected branch sizes. For our full portfolio, please visit [www.amiblu.com/amiblu-products](http://www.amiblu.com/amiblu-products).  
 Sizes can be adapted to meet transport requirements. For project-related dimensions, please contact Amiblu.

Amiblu Holding GmbH | Pischeldorfer Str. 128 | 9020 Klagenfurt | Austria | +43 463 482424 | [www.amiblu.com](http://www.amiblu.com) | [info@amiblu.com](mailto:info@amiblu.com)

© Amiblu Holding GmbH. Figures may slightly vary due to manufacturing tolerances. Amiblu does not accept any liability for errors, omissions, and subsequent changes to technical data.

# y-Piece PN 1, 45°

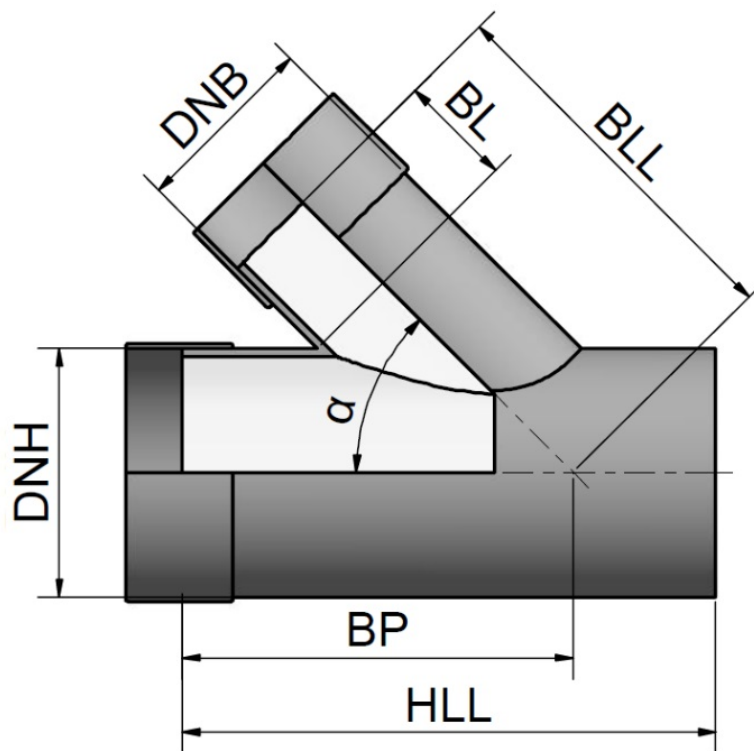

DN <sub>H</sub>	d <sub>eH</sub> [mm]	DN <sub>B</sub>	d <sub>eB</sub> [mm]	HLL [mm]	BL [mm]	BLL [mm]	BP [mm]	α [°]
1500	1499	200	220	1000	280	1450	1250	45
		500	530	1450	325	1650	1500	45
		750	752	1800	364	1800	1650	45
		1000	1026	2150	327	1900	1850	45
		1500	1499	2900	391	2200	2200	45
1535	1535	200	220	1000	305	1500	1300	45
		500	530	1450	350	1700	1500	45
		800	820	1850	355	1850	1700	45
		1100	1099	2300	365	2000	1950	45
		1535	1535	2950	397	2250	2250	45
1600	1638	200	220	1000	282	1550	1350	45
		500	530	1450	327	1750	1550	45
		800	820	1850	332	1900	1750	45
		1100	1099	2300	342	2050	2000	45
		1600	1638	3100	423	2400	2400	45
1720	1720	200	220	1000	274	1600	1400	45
		550	550	1450	309	1800	1600	45
		860	860	1950	354	2000	1850	45
		1200	1229	2500	369	2200	2150	45
		1720	1720	3200	424	2500	2500	45

Table contains selected branch sizes. For our full portfolio, please visit [www.amiblu.com/amiblu-products](http://www.amiblu.com/amiblu-products).  
 Sizes can be adapted to meet transport requirements. For project-related dimensions, please contact Amiblu.

Amiblu Holding GmbH | Pischeldorfer Str. 128 | 9020 Klagenfurt | Austria | +43 463 482424 | [www.amiblu.com](http://www.amiblu.com) | [info@amiblu.com](mailto:info@amiblu.com)

© Amiblu Holding GmbH. Figures may slightly vary due to manufacturing tolerances. Amiblu does not accept any liability for errors, omissions, and subsequent changes to technical data.

# y-Piece PN 1, 45°

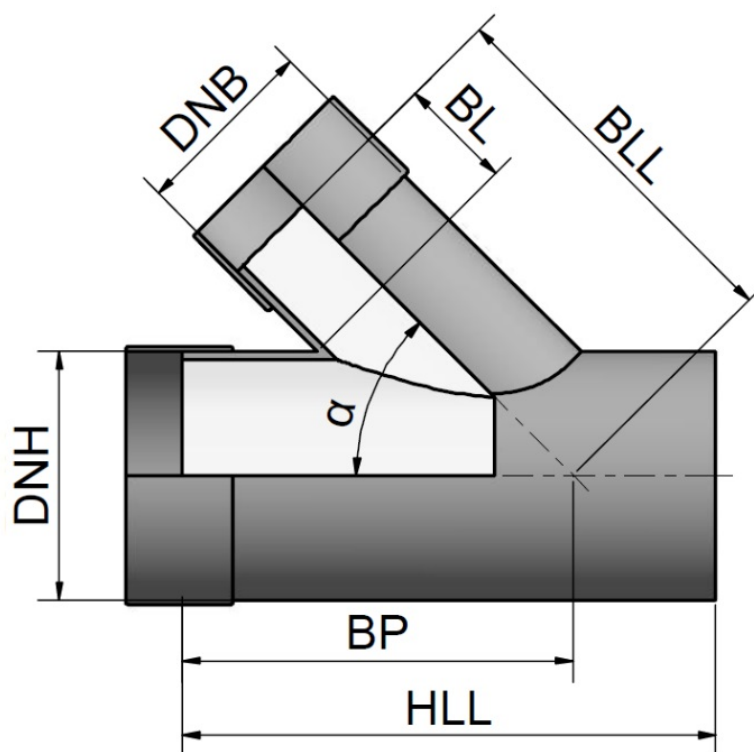

DN <sub>H</sub>	d <sub>eH</sub> [mm]	DN <sub>B</sub>	d <sub>eB</sub> [mm]	HLL [mm]	BL [mm]	BLL [mm]	BP [mm]	α [°]
1800	1842	200	220	1000	288	1700	1450	45
		550	550	1450	323	1900	1650	45
		860	860	1950	368	2100	1900	45
		1280	1280	2550	358	2300	2200	45
		1800	1842	3400	427	2650	2650	45
1940	1937	200	220	1000	270	1750	1500	45
		550	550	1450	305	1950	1700	45
		900	924	2000	368	2200	2000	45
		1400	1434	2800	363	2450	2400	45
		1940	1937	3550	412	2750	2750	45
2000	2047	200	220	1000	293	1850	1550	45
		550	550	1450	328	2050	1750	45
		900	924	2000	341	2250	2050	45
		1400	1434	2800	386	2550	2450	45
		2000	2047	3700	429	2900	2900	45
2160	2160	200	220	1000	263	1900	1600	45
		600	616	1550	315	2150	1900	45
		960	960	2050	343	2350	2150	45
		1500	1499	2900	423	2700	2550	45
		2160	2160	3900	443	3050	3050	45

Table contains selected branch sizes. For our full portfolio, please visit [www.amiblu.com/amiblu-products](http://www.amiblu.com/amiblu-products).

Sizes can be adapted to meet transport requirements. For project-related dimensions, please contact Amiblu.

Amiblu Holding GmbH | Pischeldorfer Str. 128 | 9020 Klagenfurt | Austria | +43 463 482424 | [www.amiblu.com](http://www.amiblu.com) | [info@amiblu.com](mailto:info@amiblu.com)

© Amiblu Holding GmbH. Figures may slightly vary due to manufacturing tolerances. Amiblu does not accept any liability for errors, omissions, and subsequent changes to technical data.

# y-Piece PN 1, 45°

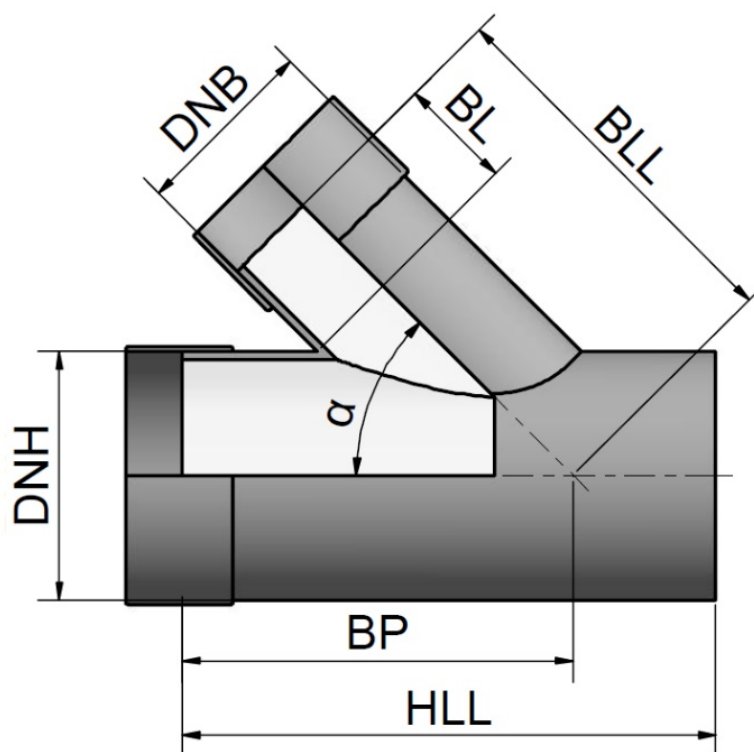

DN <sub>H</sub>	d <sub>eH</sub> [mm]	DN <sub>B</sub>	d <sub>eB</sub> [mm]	HLL [mm]	BL [mm]	BLL [mm]	BP [mm]	α [°]
2200	2250	200	220	1000	299	2000	1650	45
		600	616	1550	351	2250	1900	45
		960	960	2050	329	2400	2150	45
		1535	1535	2950	392	2750	2600	45
		2200	2250	4000	434	3150	3150	45
2400	2400	200	220	1000	293	2100	1700	45
		600	616	1550	345	2350	2000	45
		1000	1026	2150	340	2550	2300	45
		1600	1638	3100	384	2900	2750	45
		2400	2400	4250	453	3350	3350	45
2453	2453	200	220	1000	306	2150	1750	45
		600	616	1550	358	2400	2050	45
		1000	1026	2150	353	2600	2350	45
		1600	1638	3100	397	2950	2800	45
		2453	2453	4350	439	3400	3450	45
2555	2555	200	220	1000	283	2200	1800	45
		650	650	1650	368	2500	2150	45
		1100	1099	2350	344	2700	2500	45
		1720	1720	3250	383	3050	2950	45
		2555	2555	4500	466	3550	3550	45

Table contains selected branch sizes. For our full portfolio, please visit [www.amiblu.com/amiblu-products](http://www.amiblu.com/amiblu-products).  
 Sizes can be adapted to meet transport requirements. For project-related dimensions, please contact Amiblu.

Amiblu Holding GmbH | Pischeldorfer Str. 128 | 9020 Klagenfurt | Austria | +43 463 482424 | [www.amiblu.com](http://www.amiblu.com) | [info@amiblu.com](mailto:info@amiblu.com)

© Amiblu Holding GmbH. Figures may slightly vary due to manufacturing tolerances. Amiblu does not accept any liability for errors, omissions, and subsequent changes to technical data.

# y-Piece PN 1, 45°

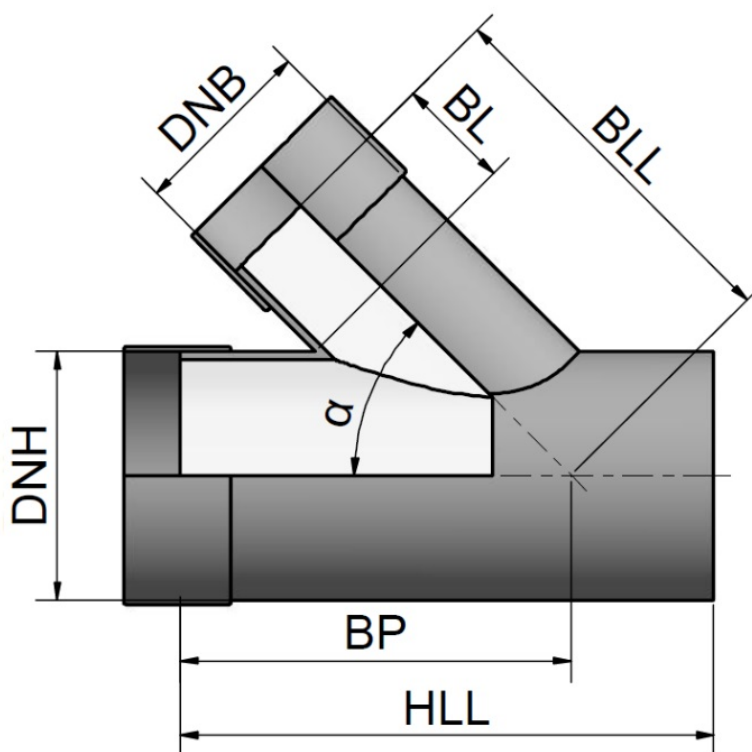

DN <sub>H</sub>	d <sub>eH</sub> [mm]	DN <sub>B</sub>	d <sub>eB</sub> [mm]	HLL [mm]	BL [mm]	BLL [mm]	BP [mm]	α [°]
3000	2999	200	220	1000	269	2500	2000	45
		650	650	1650	354	2800	2350	45
		1100	1099	2350	380	3050	2700	45
		1800	1842	3450	408	3450	3250	45
		3000	2999	5150	480	4100	4100	45
3270	3270	200	220	1000	278	2700	2150	45
		650	650	1650	363	3000	2500	45
		1200	1229	2500	373	3300	2900	45
		1940	1937	3600	419	3700	3450	45
		3270	3270	5600	503	4450	4450	45
3600	3600	200	220	1000	294	2950	2300	45
		650	650	1650	329	3200	2650	45
		1200	1229	2500	340	3500	3050	45
		1940	1937	3600	436	3950	3600	45
		3270	3270	5600	469	4650	4600	45

Table contains selected branch sizes. For our full portfolio, please visit [www.amiblu.com/amiblu-products](http://www.amiblu.com/amiblu-products).  
 Sizes can be adapted to meet transport requirements. For project-related dimensions, please contact Amiblu.

Amiblu Holding GmbH | Pischeldorfer Str. 128 | 9020 Klagenfurt | Austria | +43 463 482424 | [www.amiblu.com](http://www.amiblu.com) | [info@amiblu.com](mailto:info@amiblu.com)

© Amiblu Holding GmbH. Figures may slightly vary due to manufacturing tolerances. Amiblu does not accept any liability for errors, omissions, and subsequent changes to technical data.

# y-Piece PN 1, 60°

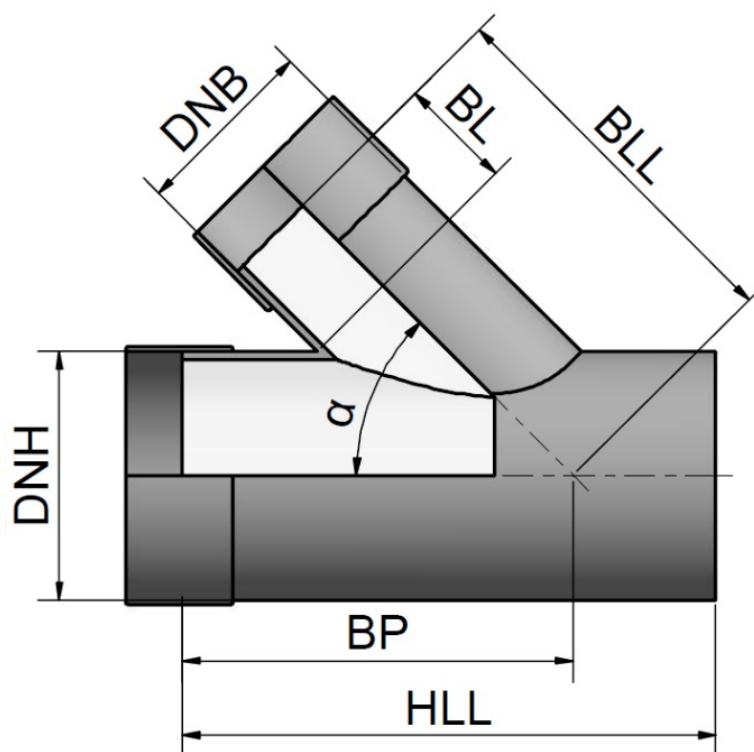

DN <sub>H</sub>	d <sub>eH</sub> [mm]	DN <sub>B</sub>	d <sub>eB</sub> [mm]	HLL [mm]	BL [mm]	BLL [mm]	BP [mm]	α [°]
200	220	200	220	800	260	450	500	60
250	272	200	220	800	280	500	500	60
		250	272	850	265	500	550	60
300	324	200	220	850	299	550	550	60
		250	272	950	284	550	600	60
		300	324	1000	319	600	600	60
350	376	200	220	850	269	550	550	60
		250	272	950	304	600	600	60
		300	324	1000	339	650	650	60
		350	376	1050	324	650	650	60
400	427	200	220	850	290	600	550	60
		250	272	950	275	600	600	60
		300	324	1000	310	650	650	60
		350	376	1050	345	700	650	60
		400	427	1100	330	700	700	60

Table contains selected branch sizes. For our full portfolio, please visit [www.amiblu.com/amiblu-products](http://www.amiblu.com/amiblu-products).  
 Sizes can be adapted to meet transport requirements. For project-related dimensions, please contact Amiblu.

Amiblu Holding GmbH | Pischeldorfer Str. 128 | 9020 Klagenfurt | Austria | +43 463 482424 | [www.amiblu.com](http://www.amiblu.com) | [info@amiblu.com](mailto:info@amiblu.com)

© Amiblu Holding GmbH. Figures may slightly vary due to manufacturing tolerances. Amiblu does not accept any liability for errors, omissions, and subsequent changes to technical data.



# y-Piece PN 1, 60°

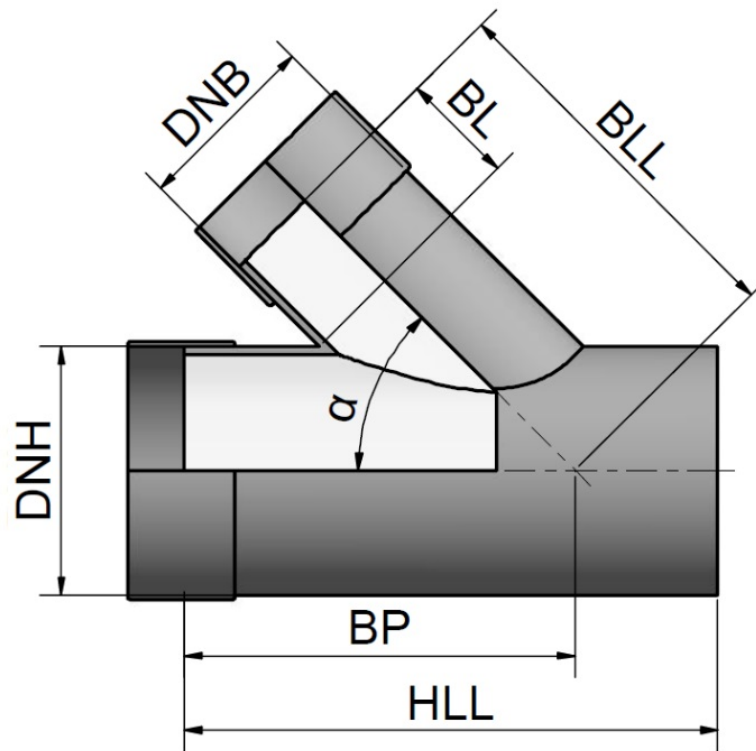

DN <sub>H</sub>	d <sub>eH</sub> [mm]	DN <sub>B</sub>	d <sub>eB</sub> [mm]	HLL [mm]	BL [mm]	BLL [mm]	BP [mm]	α [°]
450	478	200	220	850	261	600	600	60
		300	324	1000	331	700	650	60
		350	376	1050	316	700	700	60
		400	427	1100	351	750	700	60
		450	478	1200	336	750	750	60
500	530	200	220	850	281	650	600	60
		300	324	1000	351	750	700	60
		400	427	1100	321	750	750	60
		450	478	1200	306	750	800	60
		500	530	1250	341	800	800	60
550	550	200	220	850	269	650	600	60
		300	324	1000	339	750	700	60
		400	427	1100	309	750	750	60
		450	478	1200	345	800	800	60
		550	550	1250	324	800	800	60
600	616	200	220	900	281	700	650	60
		350	376	1100	336	800	750	60
		450	478	1200	306	800	800	60
		500	530	1250	341	850	850	60
		600	616	1350	317	850	900	60

Table contains selected branch sizes. For our full portfolio, please visit [www.amiblu.com/amiblu-products](http://www.amiblu.com/amiblu-products).  
 Sizes can be adapted to meet transport requirements. For project-related dimensions, please contact Amiblu.

Amiblu Holding GmbH | Pischeldorfer Str. 128 | 9020 Klagenfurt | Austria | +43 463 482424 | [www.amiblu.com](http://www.amiblu.com) | [info@amiblu.com](mailto:info@amiblu.com)

© Amiblu Holding GmbH. Figures may slightly vary due to manufacturing tolerances. Amiblu does not accept any liability for errors, omissions, and subsequent changes to technical data.

# y-Piece PN 1, 60°

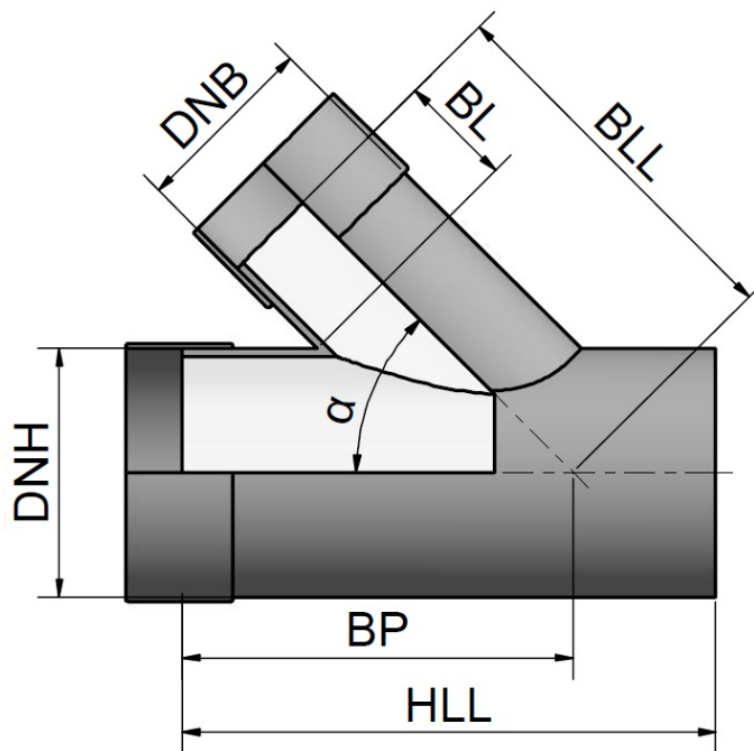

DN <sub>H</sub>	d <sub>eH</sub> [mm]	DN <sub>B</sub>	d <sub>eB</sub> [mm]	HLL [mm]	BL [mm]	BLL [mm]	BP [mm]	α [°]
650	650	200	220	900	261	700	650	60
		350	376	1100	316	800	750	60
		450	478	1200	337	850	800	60
		550	550	1300	316	850	850	60
		650	650	1400	337	900	900	60
700	718	200	220	900	272	750	700	60
		350	376	1100	327	850	800	60
		500	530	1250	333	900	850	60
		600	616	1350	358	950	900	60
		700	718	1500	328	950	1000	60
750	752	200	220	900	302	800	700	60
		350	376	1100	307	850	800	60
		500	530	1250	313	900	850	60
		600	616	1350	338	950	900	60
		750	752	1550	349	1000	1000	60
800	820	200	220	900	263	800	700	60
		400	427	1150	303	900	850	60
		550	550	1300	318	950	900	60
		650	650	1400	339	1000	950	60
		800	820	1600	340	1050	1050	60

Table contains selected branch sizes. For our full portfolio, please visit [www.amiblu.com/amiblu-products](http://www.amiblu.com/amiblu-products).  
 Sizes can be adapted to meet transport requirements. For project-related dimensions, please contact Amiblu.

Amiblu Holding GmbH | Pischeldorfer Str. 128 | 9020 Klagenfurt | Austria | +43 463 482424 | [www.amiblu.com](http://www.amiblu.com) | [info@amiblu.com](mailto:info@amiblu.com)

© Amiblu Holding GmbH. Figures may slightly vary due to manufacturing tolerances. Amiblu does not accept any liability for errors, omissions, and subsequent changes to technical data.

# y-Piece PN 1, 60°

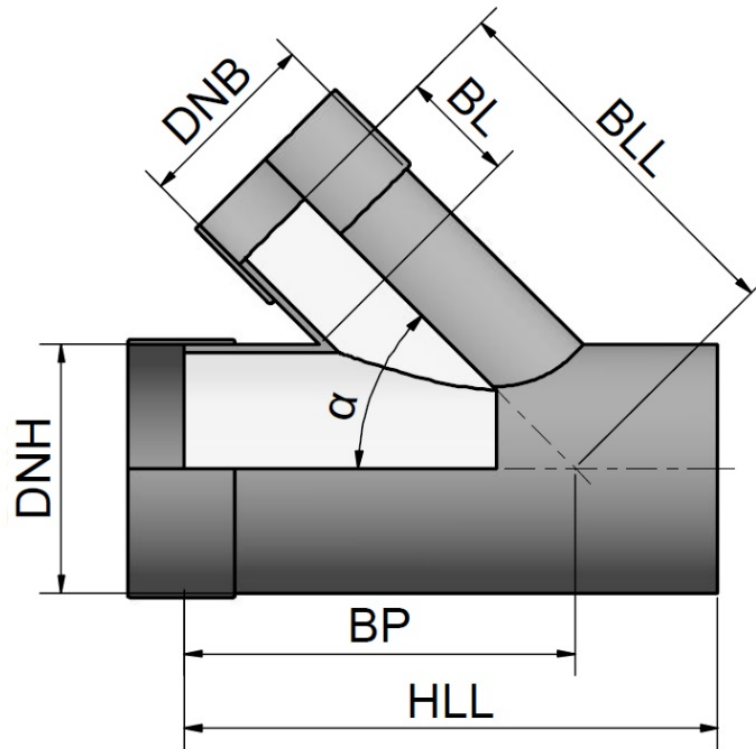

DN <sub>H</sub>	d <sub>eH</sub> [mm]	DN <sub>B</sub>	d <sub>eB</sub> [mm]	HLL [mm]	BL [mm]	BLL [mm]	BP [mm]	α [°]
860	860	200	220	900	290	850	700	60
		400	427	1150	330	950	850	60
		550	550	1300	345	1000	900	60
		700	718	1500	346	1050	1000	60
		860	860	1650	355	1100	1100	60
900	924	200	220	900	303	900	750	60
		400	427	1150	343	1000	850	60
		600	616	1350	339	1050	950	60
		750	752	1550	349	1100	1050	60
		900	924	1750	350	1150	1150	60
960	960	200	220	900	282	900	750	60
		400	427	1150	322	1000	900	60
		600	616	1350	318	1050	1000	60
		750	752	1550	329	1100	1100	60
		960	960	1800	369	1200	1200	60
1000	1026	200	220	900	294	950	750	60
		450	478	1200	320	1050	900	60
		650	650	1400	370	1150	1000	60
		800	820	1600	371	1200	1100	60
		1000	1026	1850	361	1250	1250	60

Table contains selected branch sizes. For our full portfolio, please visit [www.amiblu.com/amiblu-products](http://www.amiblu.com/amiblu-products).

Sizes can be adapted to meet transport requirements. For project-related dimensions, please contact Amiblu.

Amiblu Holding GmbH | Pischeldorfer Str. 128 | 9020 Klagenfurt | Austria | +43 463 482424 | [www.amiblu.com](http://www.amiblu.com) | [info@amiblu.com](mailto:info@amiblu.com)

© Amiblu Holding GmbH. Figures may slightly vary due to manufacturing tolerances. Amiblu does not accept any liability for errors, omissions, and subsequent changes to technical data.

# y-Piece PN 1, 60°

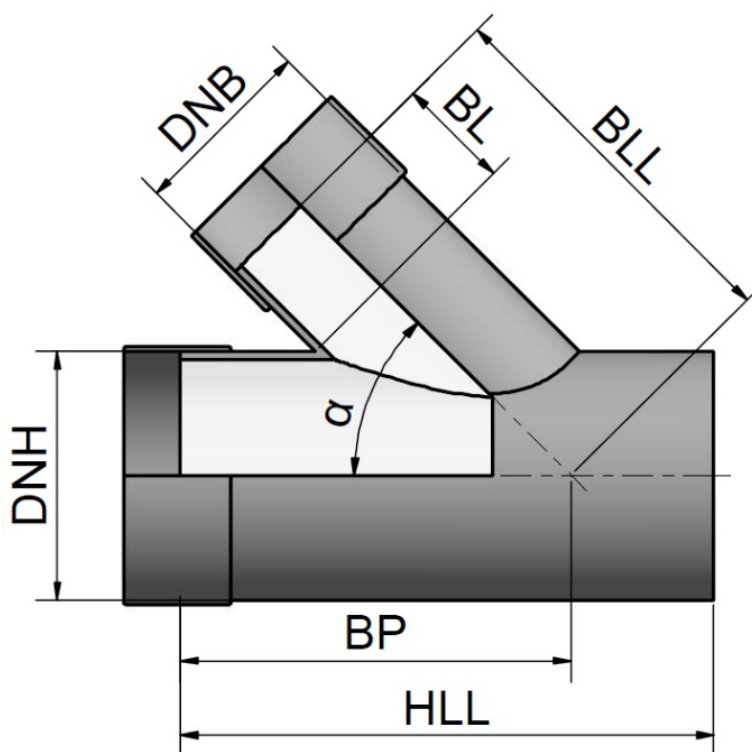

DN <sub>H</sub>	d <sub>eH</sub> [mm]	DN <sub>B</sub>	d <sub>eB</sub> [mm]	HLL [mm]	BL [mm]	BLL [mm]	BP [mm]	α [°]
1100	1099	200	220	900	302	1000	800	60
		450	478	1200	328	1100	950	60
		650	650	1400	328	1150	1050	60
		860	860	1650	367	1250	1150	60
		1100	1099	1950	348	1300	1300	60
1200	1229	200	220	900	277	1050	850	60
		450	478	1200	302	1150	1000	60
		700	718	1500	333	1250	1150	60
		900	924	1750	324	1300	1250	60
		1200	1229	2100	386	1450	1450	60
1280	1280	200	220	900	298	1100	850	60
		450	478	1200	323	1200	1000	60
		700	718	1500	354	1300	1150	60
		900	924	1750	344	1350	1250	60
		1280	1280	2200	342	1450	1500	60
1400	1434	200	220	900	309	1200	900	60
		500	530	1250	319	1300	1050	60
		750	752	1550	355	1400	1200	60
		960	960	1800	345	1450	1350	60
		1400	1434	2400	358	1600	1650	60

Table contains selected branch sizes. For our full portfolio, please visit [www.amiblu.com/amiblu-products](http://www.amiblu.com/amiblu-products).  
 Sizes can be adapted to meet transport requirements. For project-related dimensions, please contact Amiblu.

Amiblu Holding GmbH | Pischeldorfer Str. 128 | 9020 Klagenfurt | Austria | +43 463 482424 | [www.amiblu.com](http://www.amiblu.com) | [info@amiblu.com](mailto:info@amiblu.com)

© Amiblu Holding GmbH. Figures may slightly vary due to manufacturing tolerances. Amiblu does not accept any liability for errors, omissions, and subsequent changes to technical data.

# y-Piece PN 1, 60°

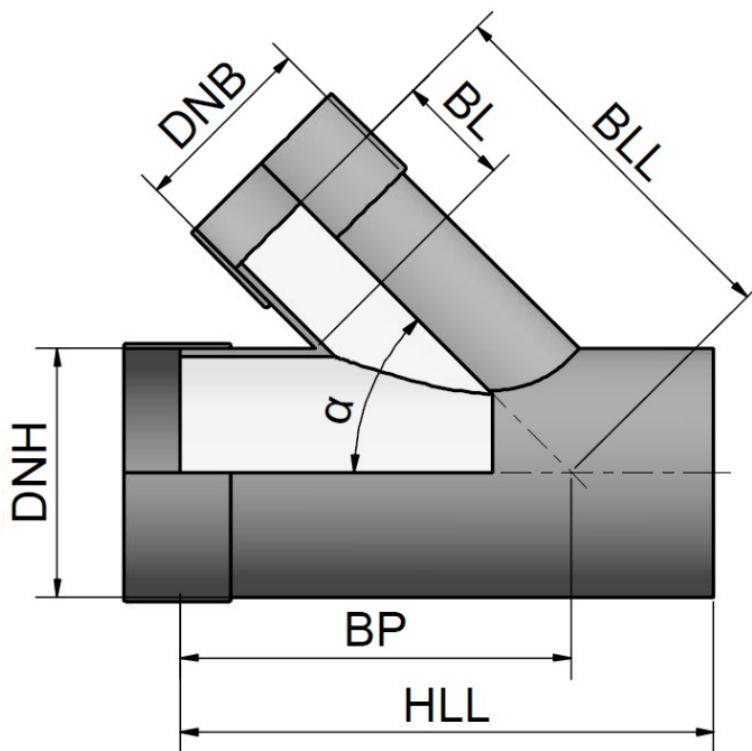

DN <sub>H</sub>	d <sub>eH</sub> [mm]	DN <sub>B</sub>	d <sub>eB</sub> [mm]	HLL [mm]	BL [mm]	BLL [mm]	BP [mm]	α [°]
1500	1499	200	220	950	271	1200	950	60
		500	530	1300	332	1350	1100	60
		750	752	1600	368	1450	1250	60
		1000	1026	1900	338	1500	1400	60
		1500	1499	2500	402	1700	1700	60
1535	1535	200	220	950	300	1250	950	60
		500	530	1300	311	1350	1100	60
		800	820	1650	327	1450	1300	60
		1100	1099	2000	347	1550	1450	60
		1535	1535	2550	421	1750	1750	60
1600	1638	200	220	950	291	1300	950	60
		500	530	1300	351	1450	1150	60
		800	820	1650	368	1550	1300	60
		1100	1099	2000	387	1650	1500	60
		1600	1638	2650	382	1800	1800	60
1720	1720	200	220	950	294	1350	1000	60
		550	550	1350	348	1500	1200	60
		860	860	1700	359	1600	1350	60
		1200	1229	2150	352	1700	1600	60
		1720	1720	2750	411	1900	1900	60

Table contains selected branch sizes. For our full portfolio, please visit [www.amiblu.com/amiblu-products](http://www.amiblu.com/amiblu-products).  
 Sizes can be adapted to meet transport requirements. For project-related dimensions, please contact Amiblu.

Amiblu Holding GmbH | Pischeldorfer Str. 128 | 9020 Klagenfurt | Austria | +43 463 482424 | [www.amiblu.com](http://www.amiblu.com) | [info@amiblu.com](mailto:info@amiblu.com)

© Amiblu Holding GmbH. Figures may slightly vary due to manufacturing tolerances. Amiblu does not accept any liability for errors, omissions, and subsequent changes to technical data.

# y-Piece PN 1, 60°

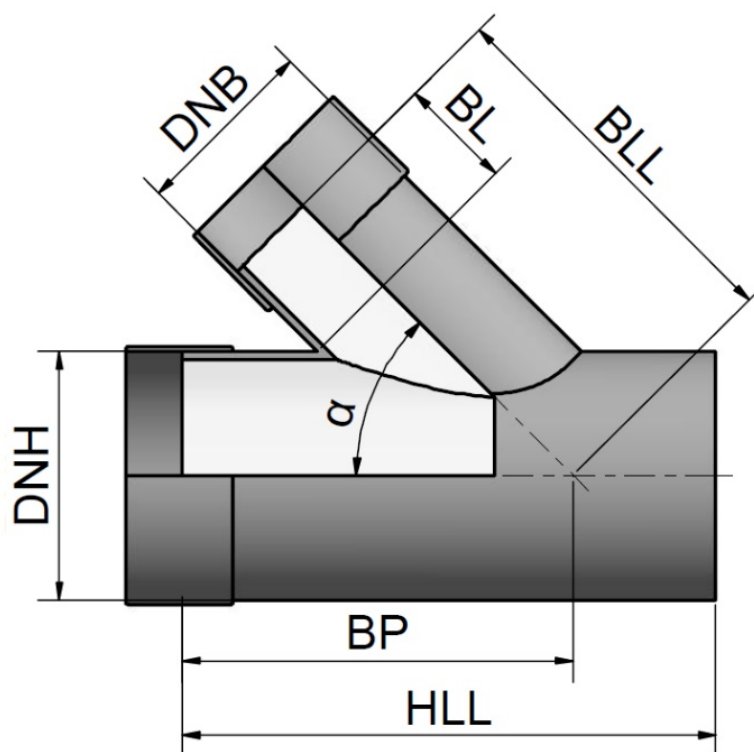

DN <sub>H</sub>	d <sub>eH</sub> [mm]	DN <sub>B</sub>	d <sub>eB</sub> [mm]	HLL [mm]	BL [mm]	BLL [mm]	BP [mm]	α [°]
1800	1842	200	220	950	273	1400	1050	60
		550	550	1350	328	1550	1250	60
		860	860	1700	338	1650	1400	60
		1280	1280	2200	367	1800	1650	60
		1800	1842	2900	405	2000	2000	60
1940	1937	200	220	950	268	1450	1050	60
		550	550	1350	323	1600	1250	60
		900	924	1800	365	1750	1500	60
		1400	1434	2400	368	1900	1800	60
		1940	1937	3050	423	2100	2100	60
2000	2047	200	220	950	305	1550	1100	60
		550	550	1350	309	1650	1300	60
		900	924	1800	352	1800	1500	60
		1400	1434	2400	354	1950	1800	60
		2000	2047	3200	427	2200	2200	60
2160	2160	200	220	950	289	1600	1100	60
		600	616	1400	325	1750	1350	60
		960	960	1800	326	1850	1550	60
		1500	1499	2500	420	2100	1900	60
		2160	2160	3300	429	2300	2300	60

Table contains selected branch sizes. For our full portfolio, please visit [www.amiblu.com/amiblu-products](http://www.amiblu.com/amiblu-products).  
 Sizes can be adapted to meet transport requirements. For project-related dimensions, please contact Amiblu.

Amiblu Holding GmbH | Pischeldorfer Str. 128 | 9020 Klagenfurt | Austria | +43 463 482424 | [www.amiblu.com](http://www.amiblu.com) | [info@amiblu.com](mailto:info@amiblu.com)

© Amiblu Holding GmbH. Figures may slightly vary due to manufacturing tolerances. Amiblu does not accept any liability for errors, omissions, and subsequent changes to technical data.

# y-Piece PN 1, 60°

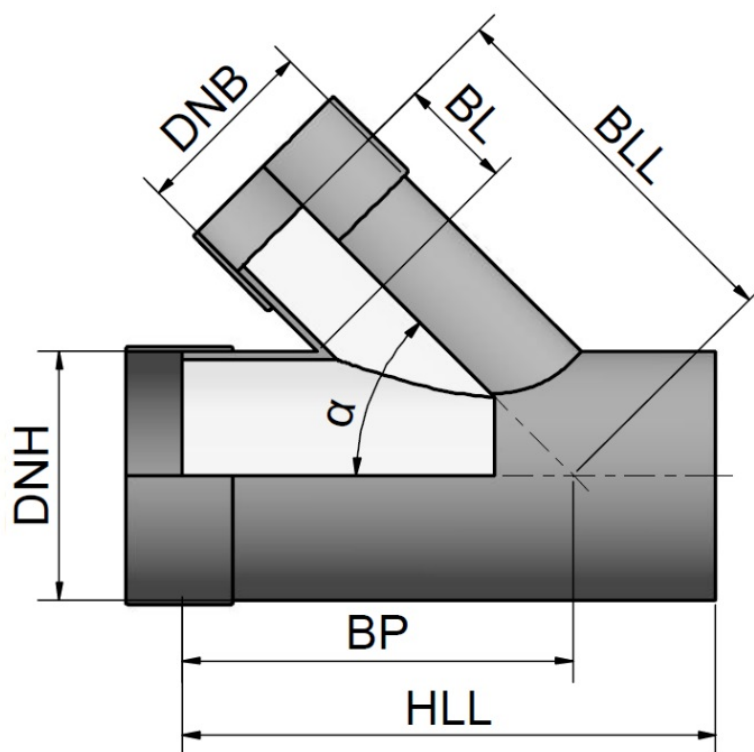

DN <sub>H</sub>	d <sub>eH</sub> [mm]	DN <sub>B</sub>	d <sub>eB</sub> [mm]	HLL [mm]	BL [mm]	BLL [mm]	BP [mm]	α [°]
2200	2250	200	220	950	288	1650	1150	60
		600	616	1400	323	1800	1350	60
		960	960	1800	324	1900	1550	60
		1535	1535	2550	408	2150	1950	60
		2200	2250	3450	452	2400	2400	60
2400	2400	200	220	950	301	1750	1200	60
		600	616	1400	337	1900	1400	60
		1000	1026	1900	368	2050	1650	60
		1600	1638	2650	392	2250	2050	60
		2400	2400	3650	422	2500	2550	60
2453	2453	200	220	950	270	1750	1200	60
		600	616	1400	356	1950	1450	60
		1000	1026	1900	338	2050	1700	60
		1600	1638	2650	411	2300	2050	60
		2453	2453	3700	426	2550	2600	60
2555	2555	200	220	950	261	1800	1250	60
		650	650	1500	337	2000	1500	60
		1100	1099	2050	358	2150	1800	60
		1720	1720	2800	378	2350	2150	60
		2555	2555	3850	437	2650	2700	60

Table contains selected branch sizes. For our full portfolio, please visit [www.amiblu.com/amiblu-products](http://www.amiblu.com/amiblu-products).  
 Sizes can be adapted to meet transport requirements. For project-related dimensions, please contact Amiblu.

Amiblu Holding GmbH | Pischeldorfer Str. 128 | 9020 Klagenfurt | Austria | +43 463 482424 | [www.amiblu.com](http://www.amiblu.com) | [info@amiblu.com](mailto:info@amiblu.com)

© Amiblu Holding GmbH. Figures may slightly vary due to manufacturing tolerances. Amiblu does not accept any liability for errors, omissions, and subsequent changes to technical data.

# y-Piece PN 1, 60°

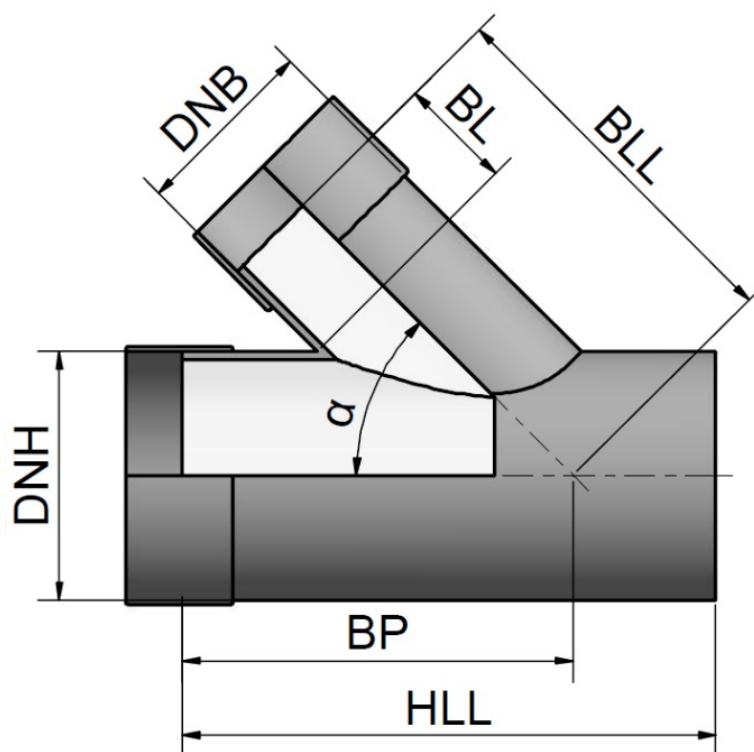

DN <sub>H</sub>	d <sub>eH</sub> [mm]	DN <sub>B</sub>	d <sub>eB</sub> [mm]	HLL [mm]	BL [mm]	BLL [mm]	BP [mm]	α [°]
3000	2999	200	220	950	305	2100	1350	60
		650	650	1500	331	2250	1650	60
		1100	1099	2050	351	2400	1900	60
		1800	1842	2950	387	2650	2350	60
		3000	2999	4400	453	3050	3100	60
3270	3270	200	220	950	299	2250	1450	60
		650	650	1500	325	2400	1700	60
		1200	1229	2200	357	2600	2050	60
		1940	1937	3100	403	2850	2500	60
		3270	3270	4750	468	3300	3350	60
3600	3600	200	220	950	308	2450	1550	60
		650	650	1500	334	2600	1800	60
		1200	1229	2200	367	2800	2150	60
		1940	1937	3100	412	3050	2600	60
		3270	3270	4750	478	3500	3450	60

Table contains selected branch sizes. For our full portfolio, please visit [www.amiblu.com/amiblu-products](http://www.amiblu.com/amiblu-products).  
 Sizes can be adapted to meet transport requirements. For project-related dimensions, please contact Amiblu.

Amiblu Holding GmbH | Pischeldorfer Str. 128 | 9020 Klagenfurt | Austria | +43 463 482424 | [www.amiblu.com](http://www.amiblu.com) | [info@amiblu.com](mailto:info@amiblu.com)

© Amiblu Holding GmbH. Figures may slightly vary due to manufacturing tolerances. Amiblu does not accept any liability for errors, omissions, and subsequent changes to technical data.



# Notes

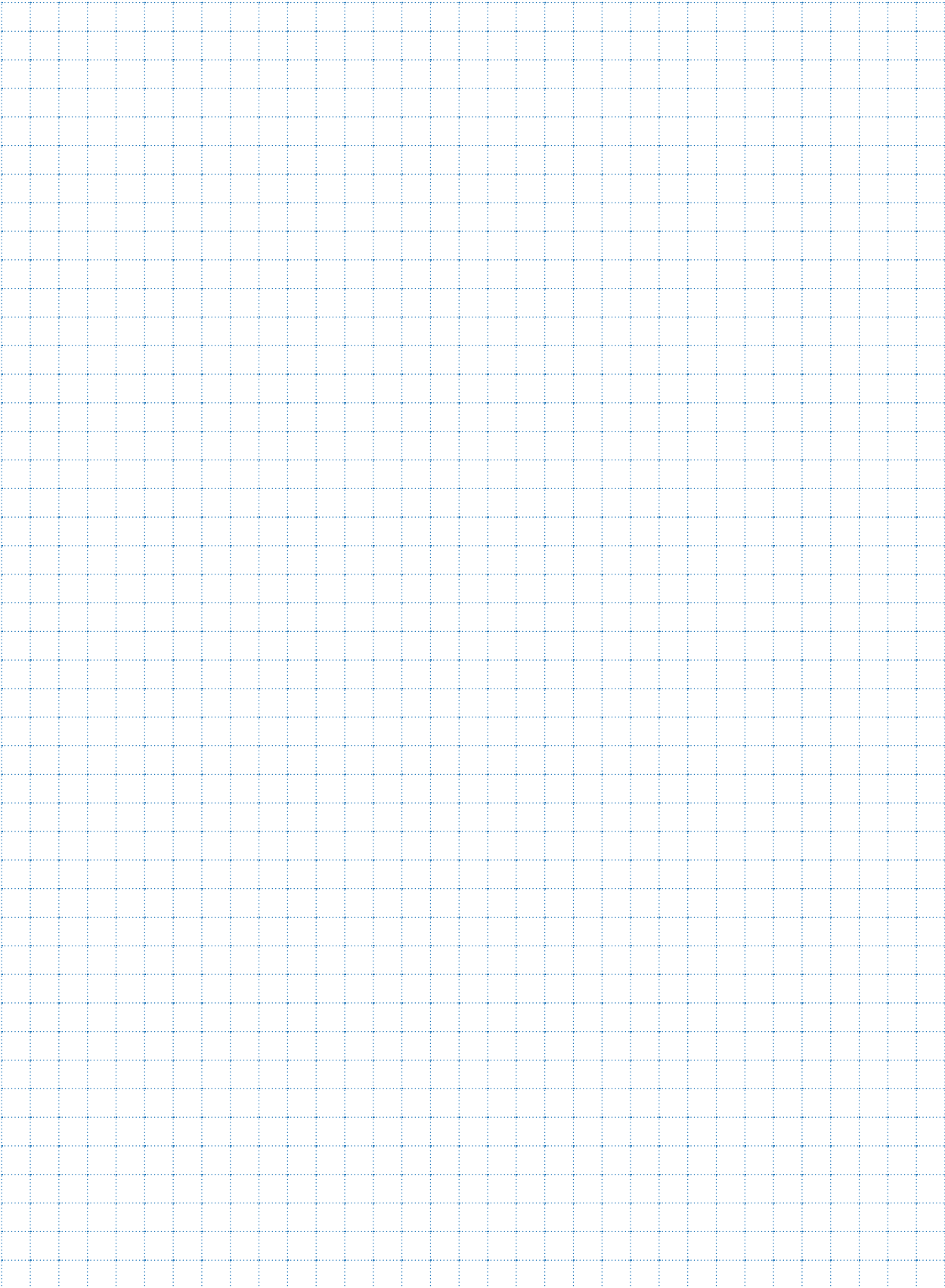

# Notes

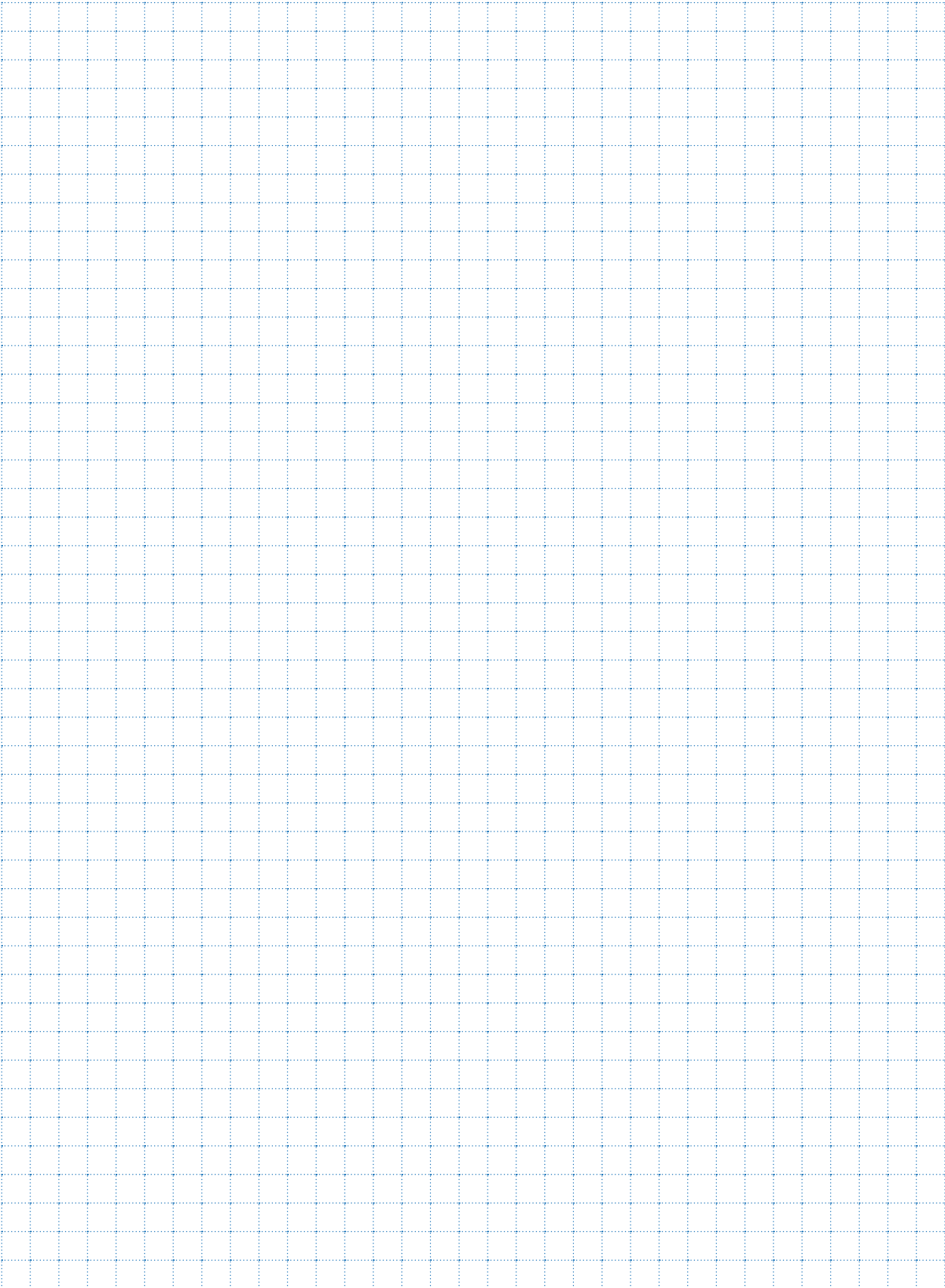

# Notes

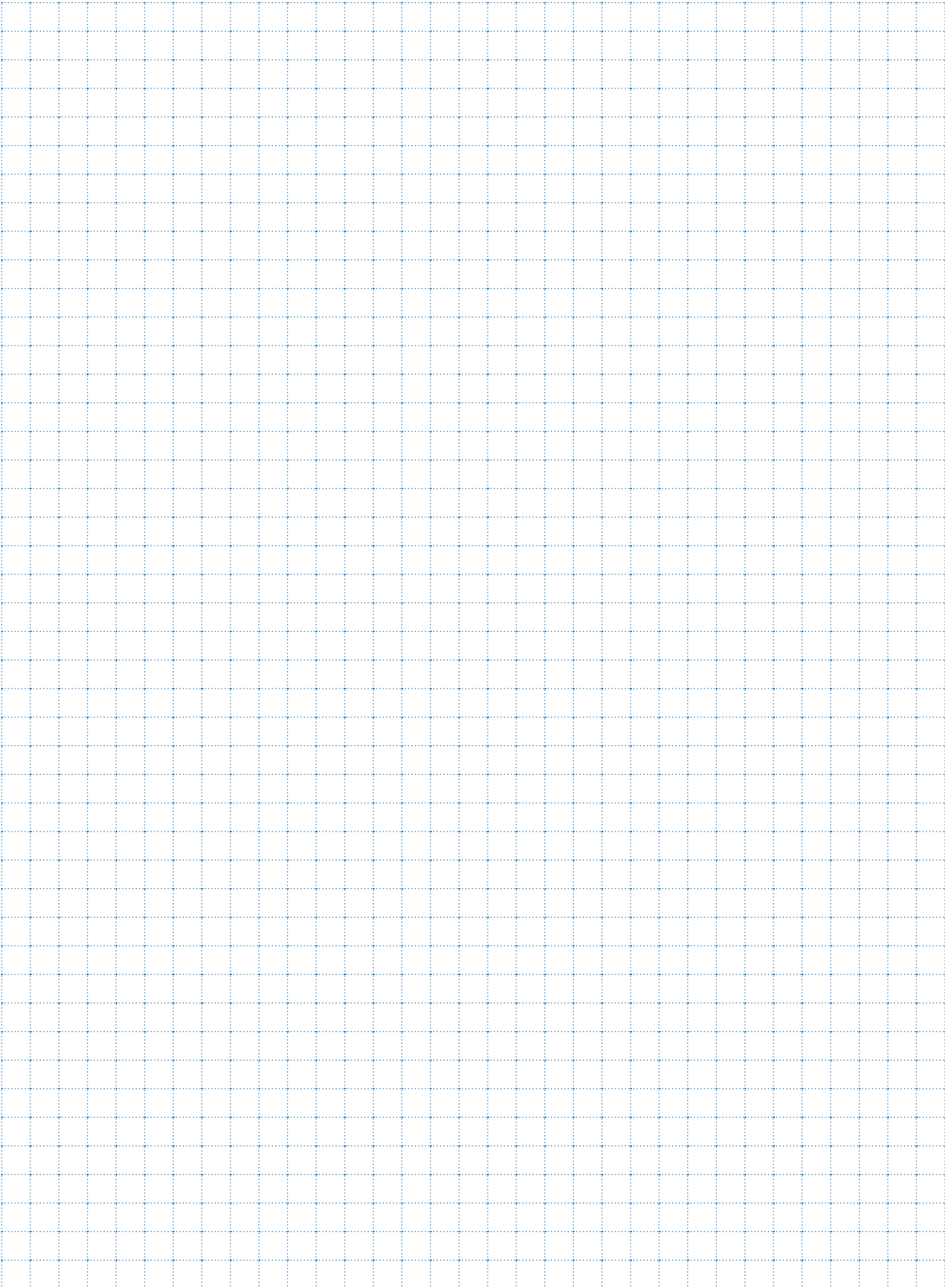

# Why there is nothing else like an Amiblu pipe system



Engineered for the next 150 years



Service-focused partners to solve your problems



Innovation to challenge the status quo



## Amiblu®

Explore more on [amiblu.com](https://www.amiblu.com) or contact your local partner for sustainable GRP pipe solutions.

All rights reserved. No part of this document may be reproduced in any form or by any means without prior written permission. All data, especially technical data, is subject to subsequent modifications. The given information is not binding and must therefore be checked and, if necessary, revised in each individual case. Amiblu and the companies affiliated with Amiblu are not liable for the advertising statements in this advertising brochure. In particular, Amiblu makes it clear that the advertising statements may not reflect the actual product characteristics and are for advertising purposes only, and therefore these statements do not form part of any contract for the purchase of the products advertised herein. © Amiblu Holding GmbH, Publication: 06/2020 | Rev. 1.3